



**ACUSTÍKA® no mantiene stock de las molduras que aparecen en este catálogo. El estar incluidas en éste catálogo significa que disponemos de las fresas necesarias para poder fabricarlas, a partir de ahí el cliente podrá hacer alguna variación que crea necesaria, previa consulta con nuestro Dpto. Comercial. Medidas en mm.**

ACUSTÍKA® does not keep stock of the moulding shown in this catalogue. Being included in this catalogue means that we have the necessary tools for making them, so, the client can make any variation after consulting with our Sales Department. Measures in mm.

*ACUSTÍKA® ne dispose pas en stock des moulures présentées sur ce catalogue. Le fait de les inclure sur ce catalogue signifie que nous disposons des outils nécessaires pour leur fabrication. Sur cette base le client pourra réaliser quelques modifications si nécessaire, avec au préalable une consultation de notre département commercial. Mesures en mm.*



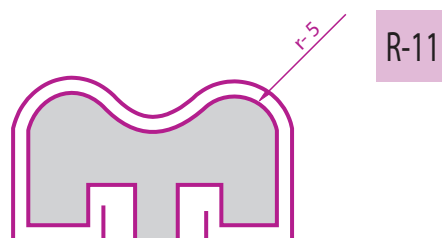
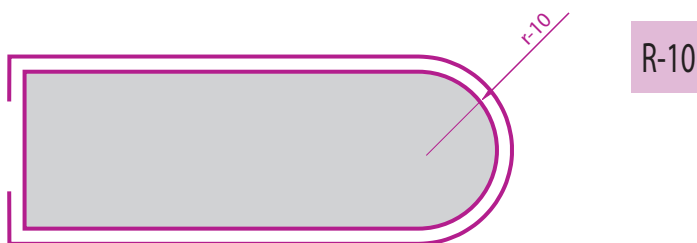
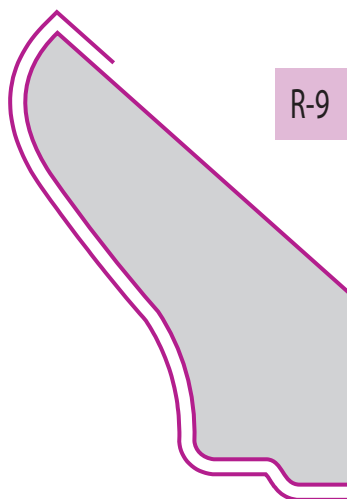
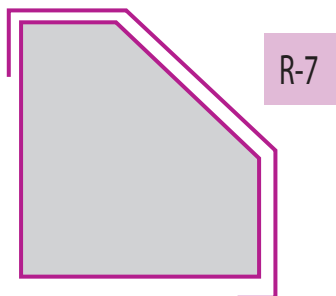
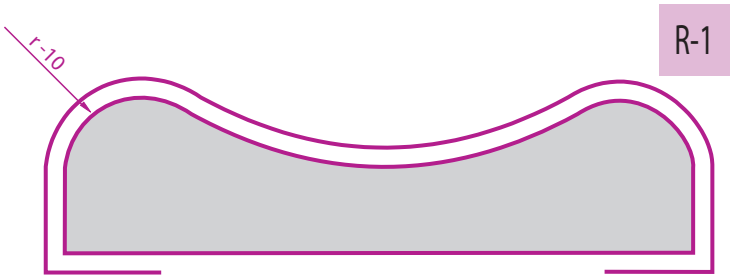

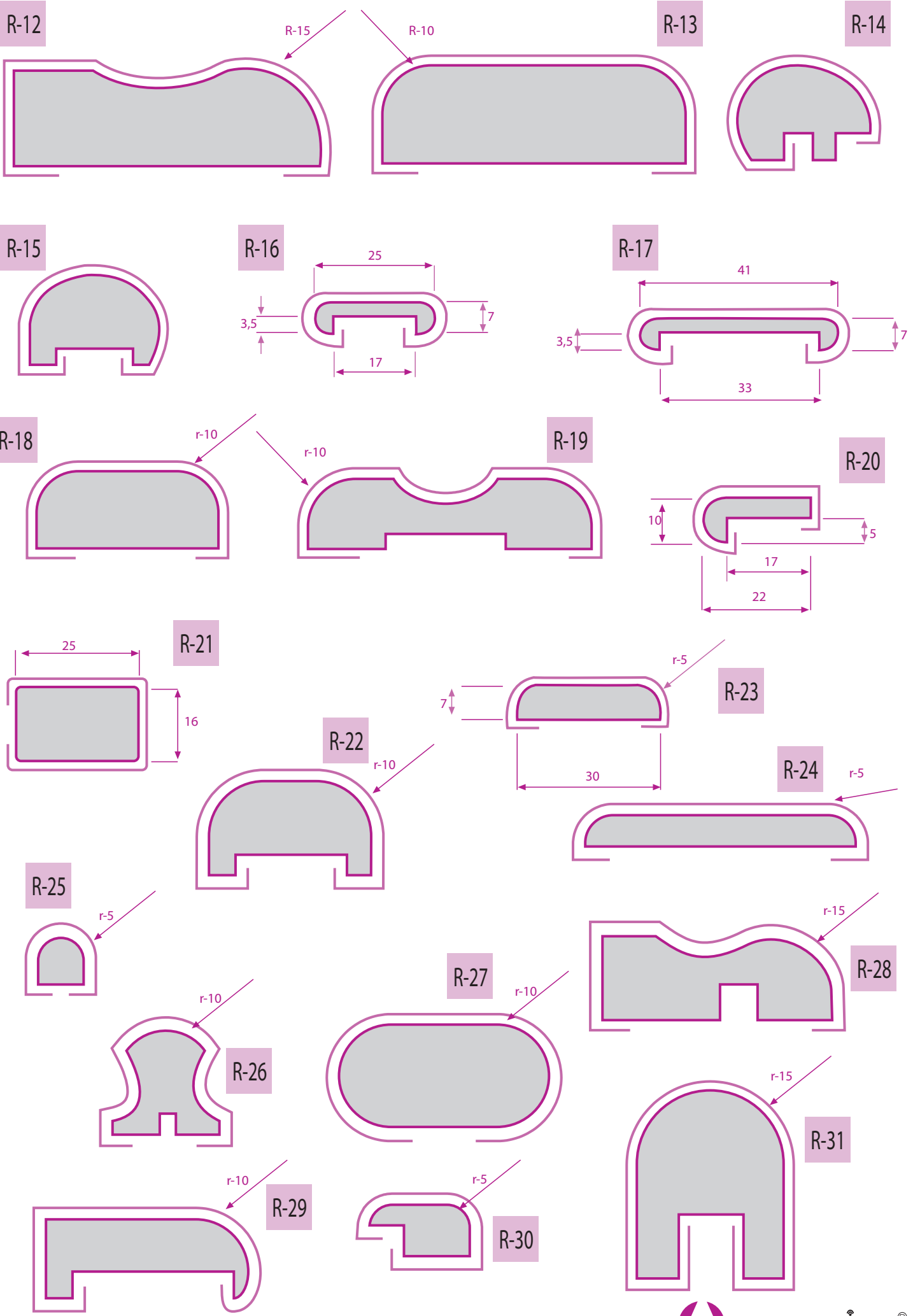

R-32



R-33

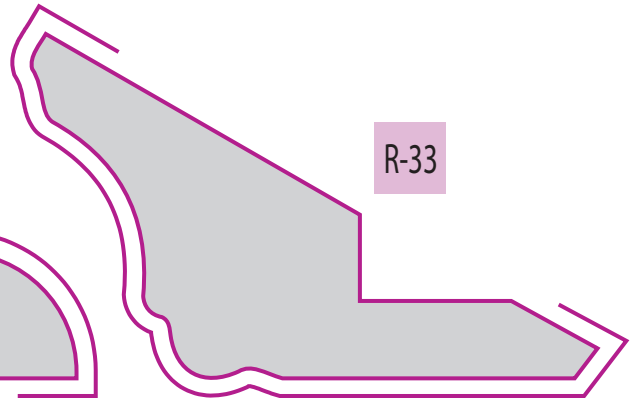

R-35

16

55



R-37

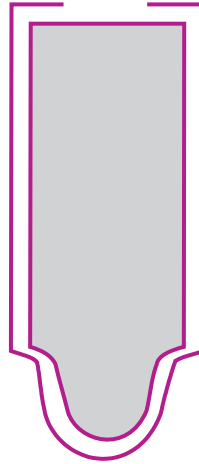

R-36

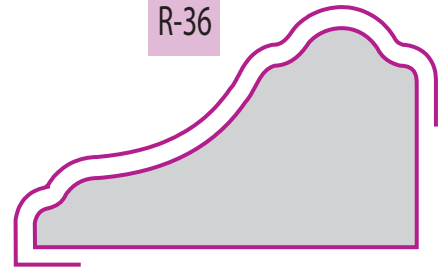

R-34

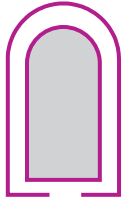

R-38

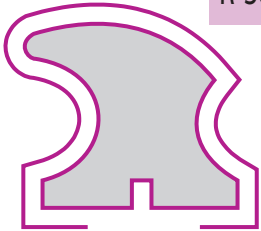

R-39

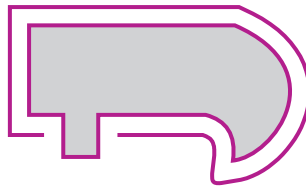

R-40

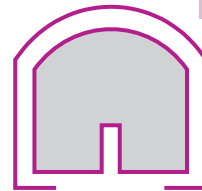

R-42



R-43

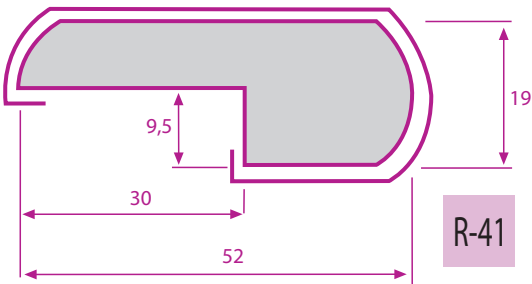
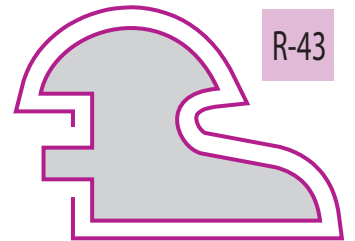

R-41

R-45

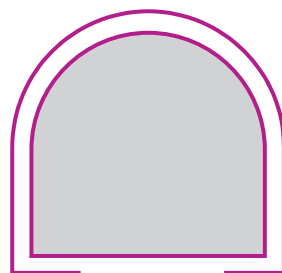

R-46

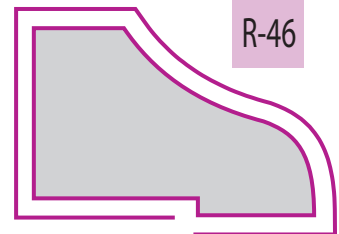

R-44

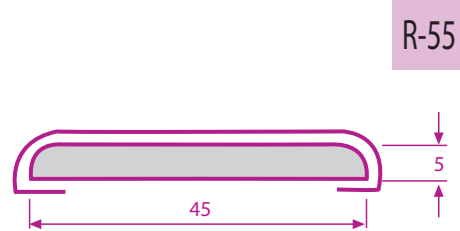
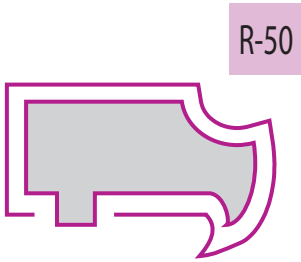
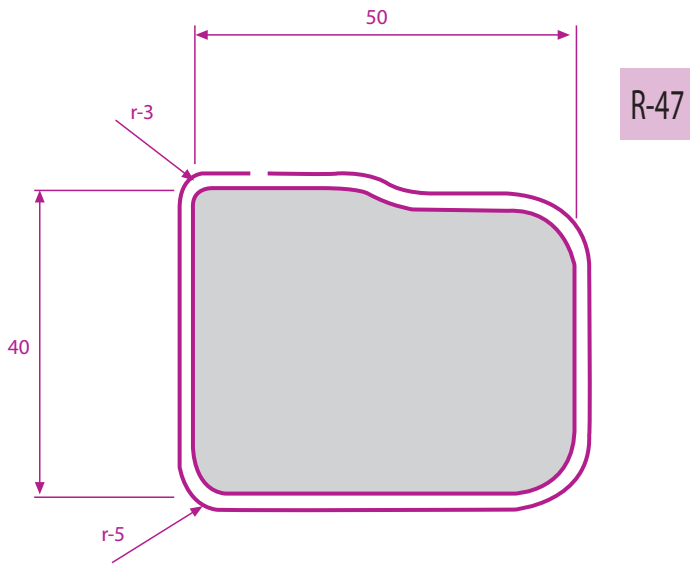

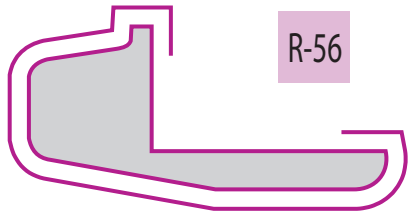

R-56



R-57



R-58



R-59

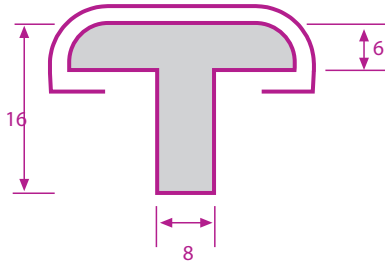

R-60

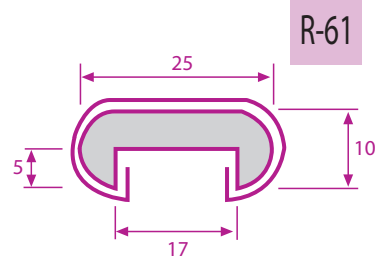

R-61



R-62



R-63



R-64

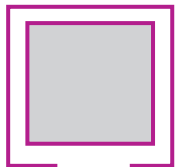

R-65

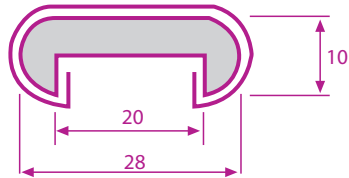

R-66

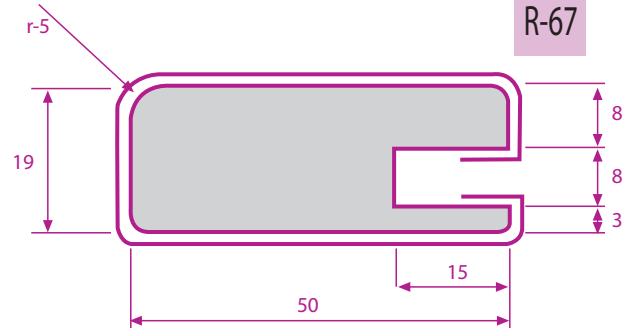

R-67



R-68

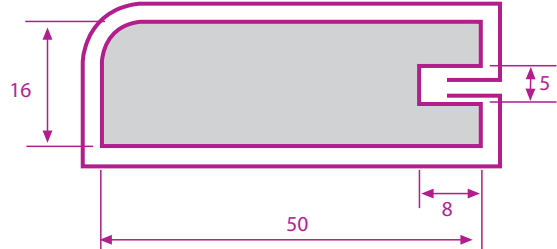

R-69



R-70



R-71



R-72

R-73

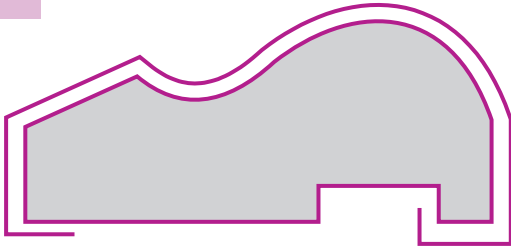

R-74



R-75

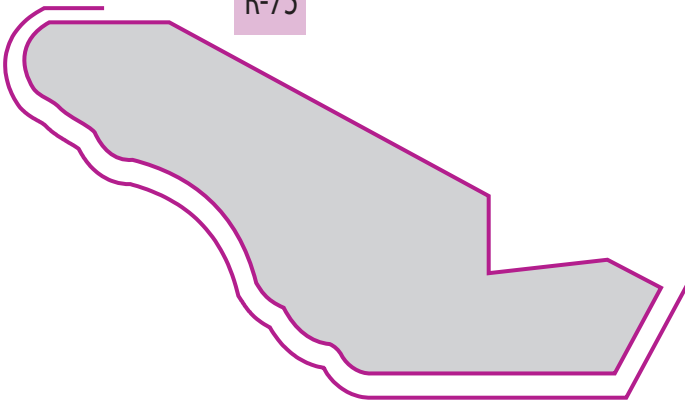

R-76

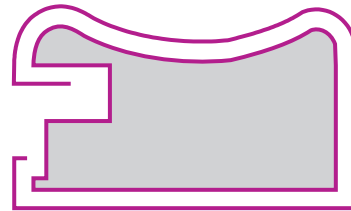

R-77



R-78



R-80



R-81





R-82

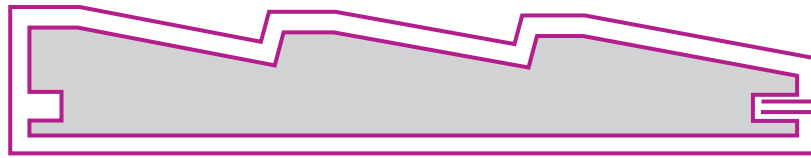

R-83



R-84

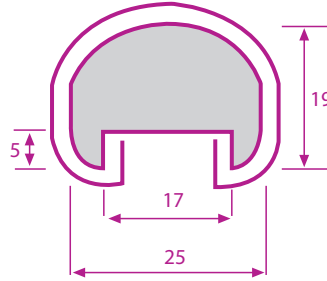

R-85

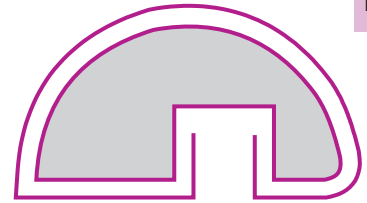

R-86

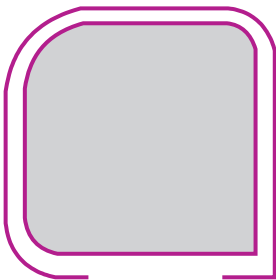

R-87



R-88

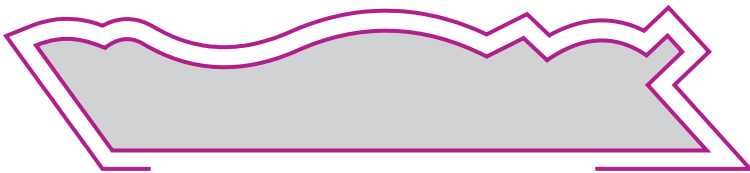

R-89

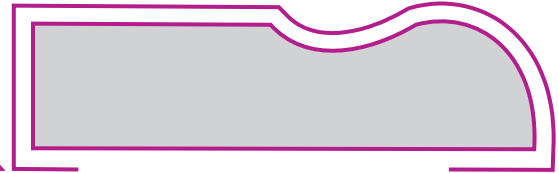

R-90

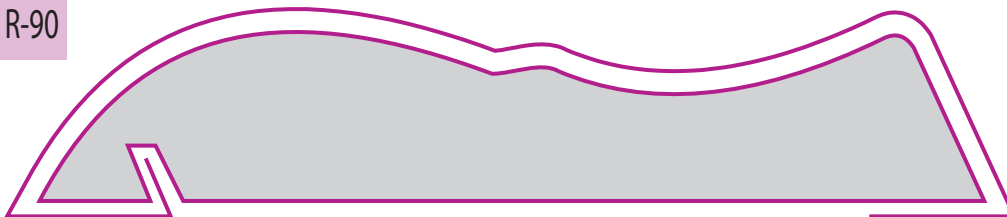

R-91



R-92

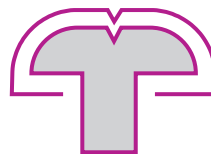

R-93

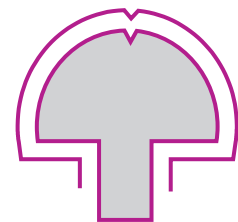

R-94

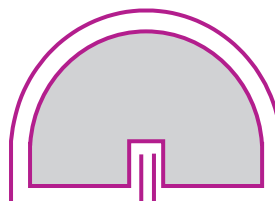

R-95



R-96



R-97



R-98



R-99

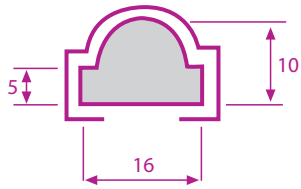
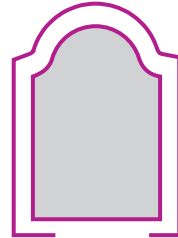

R-100

R-101



R-102



R-103

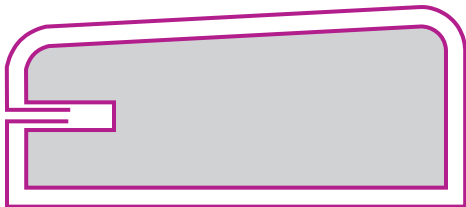

R-104

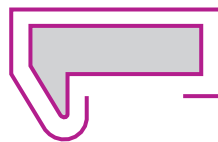

R-105



R-106



R-107



R-108

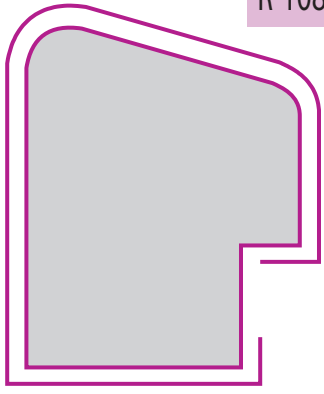

R-109

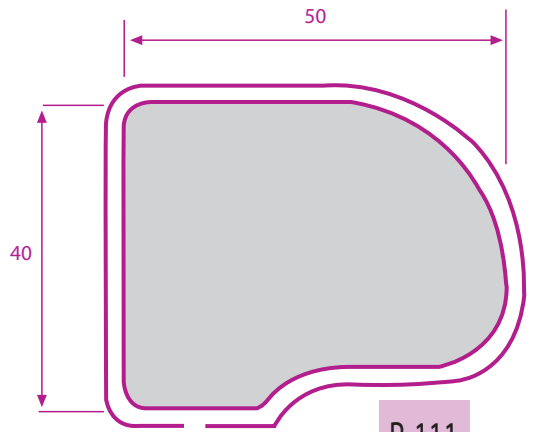
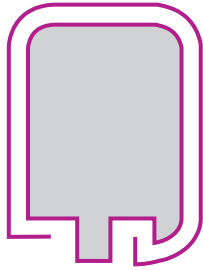

R-111

R-112



R-110

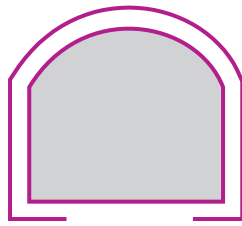

R-113



R-115



R-116

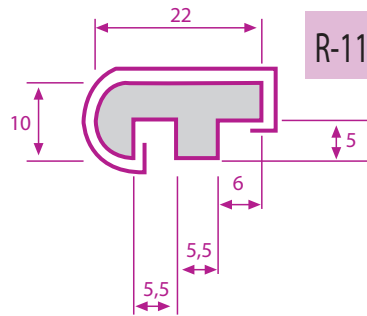

R-117

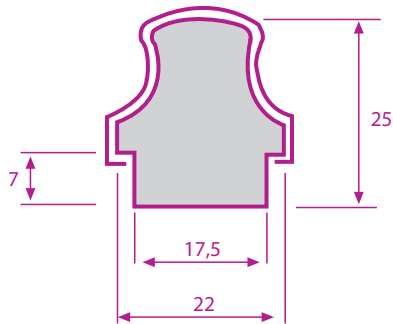

R-118

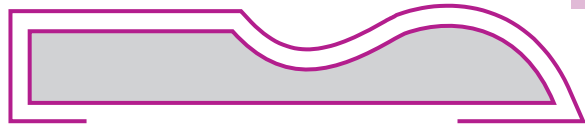

R-119

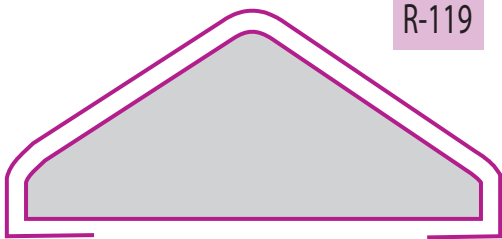

R-120



R-121

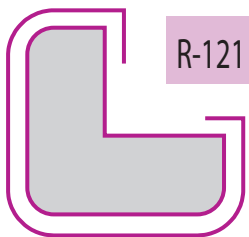

R-122

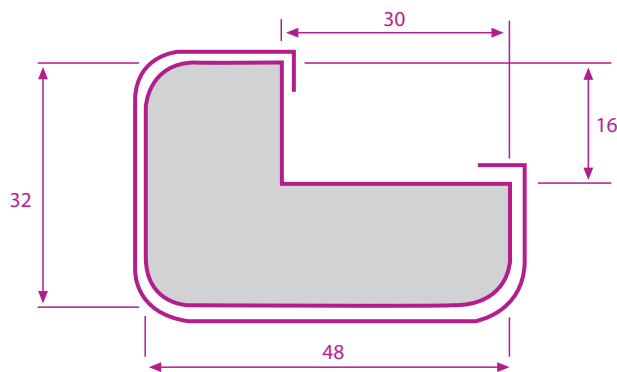

R-123



R-124



R-125

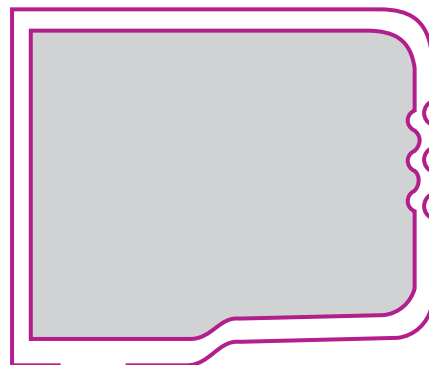

R-126

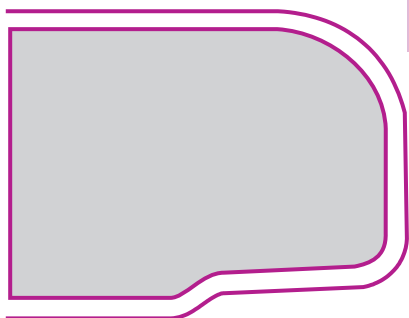

R-128

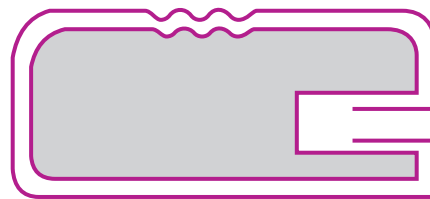

R-127

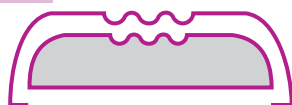

R-129

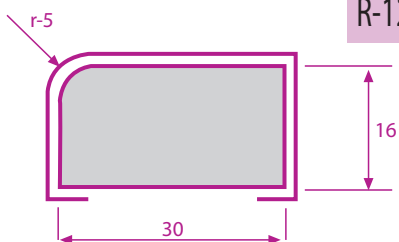

R-130



R-131

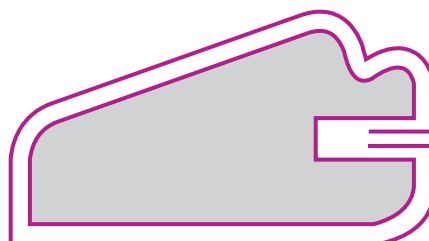

R-132

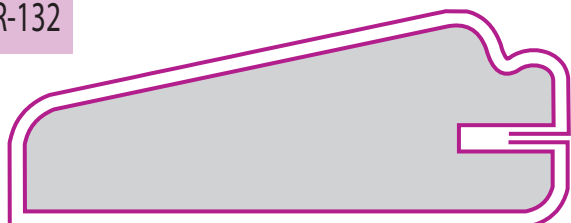

R-133

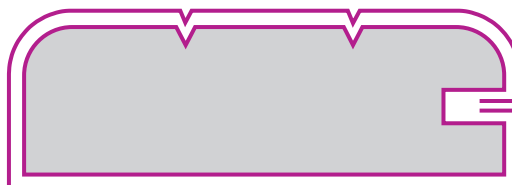

R-134



R-135

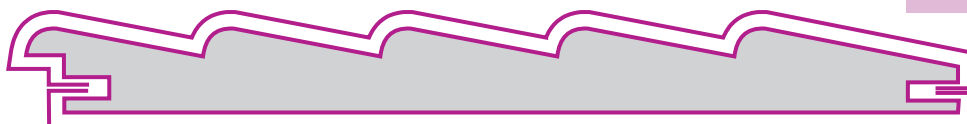

R-136

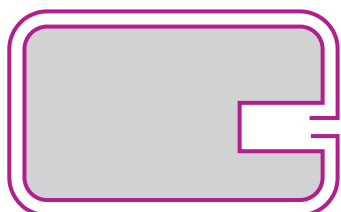

R-139

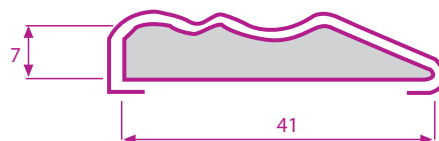

R-137

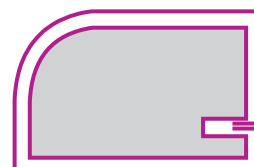

R-140



R-141



R-143

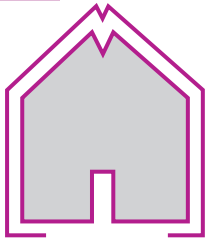

R-144

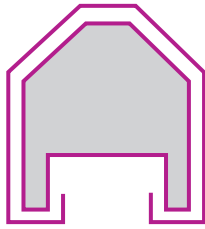

R-145



R-146

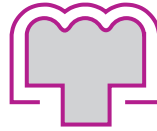

R-148

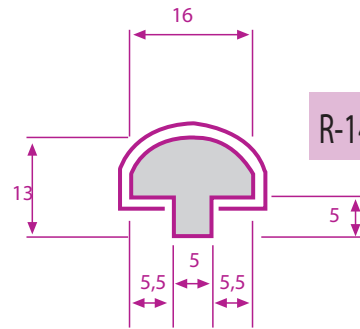
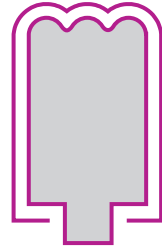

R-147

R-149

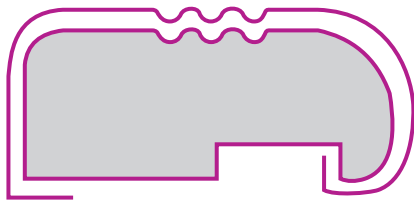

R-150

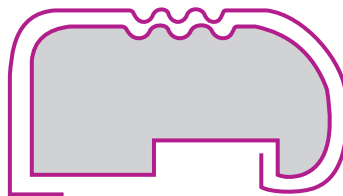

R-151

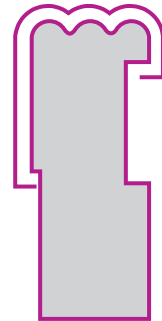

R-152



R-153



R-154

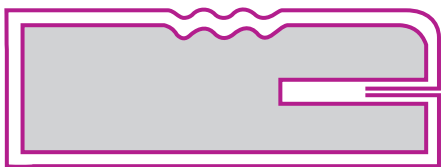

R-155

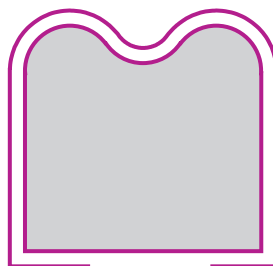

R-156



R-158



R-159

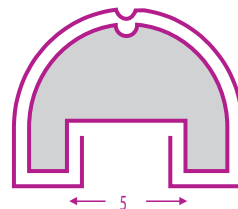

R-160



R-162

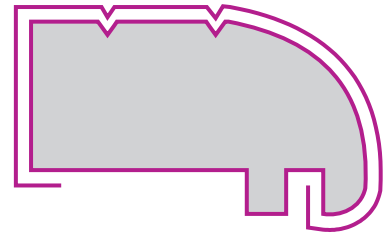

R-161

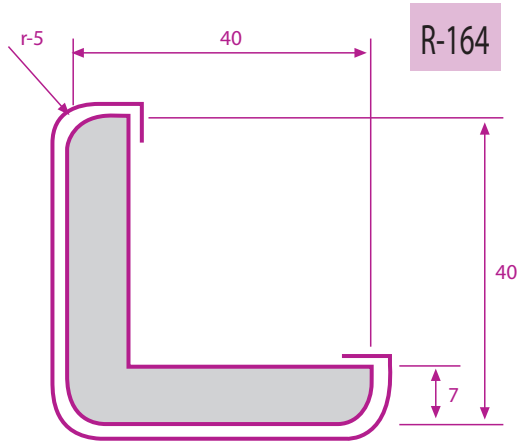

R-164

R-165

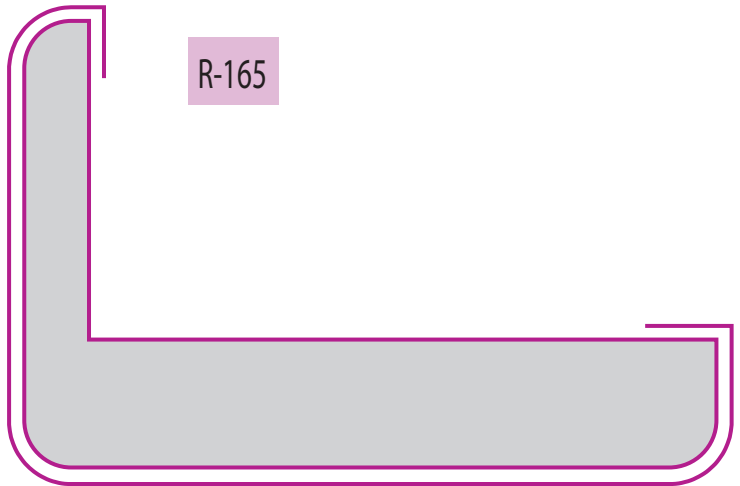

R-169



R-170



R-172

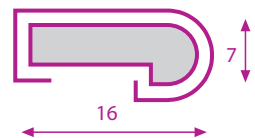

R-173

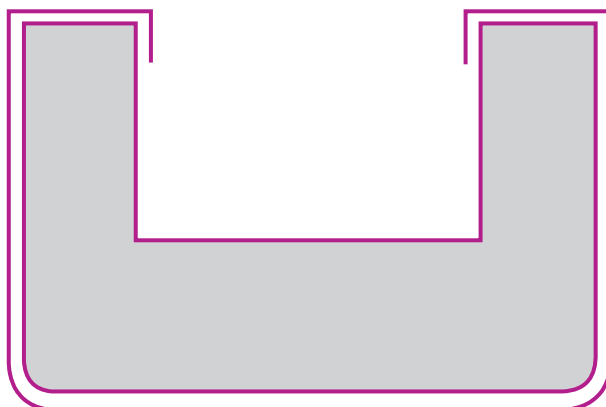

R-175

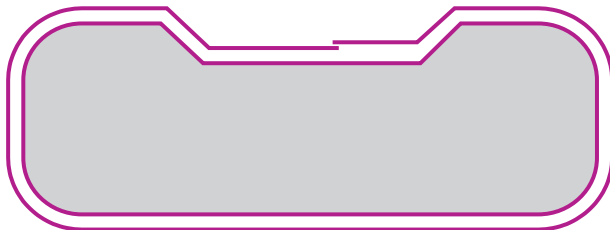

R-176

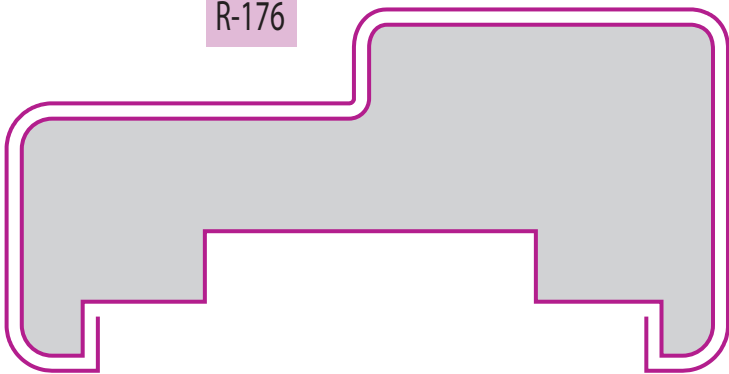

R-177

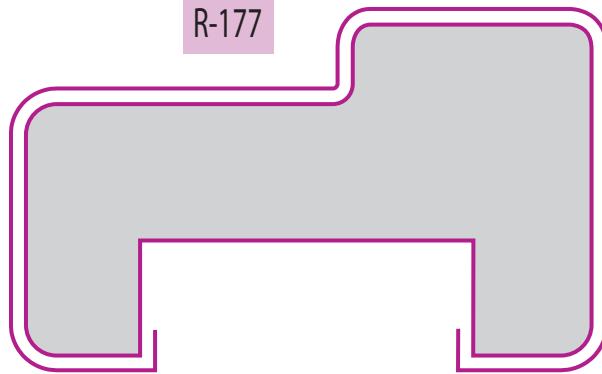

R-178

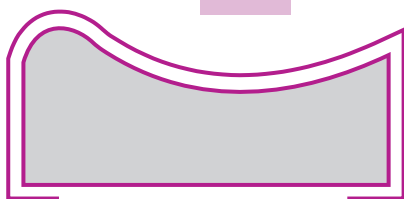

R-179

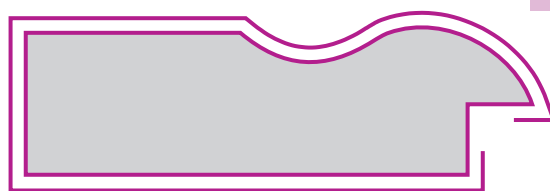

R-180

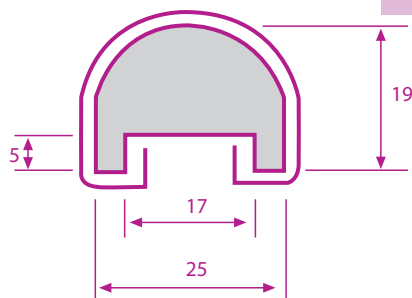

R-181

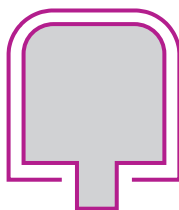

R-182



R-183



R-184

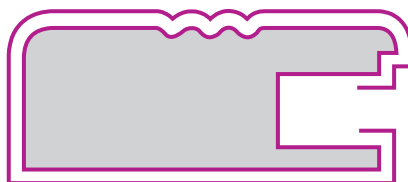

R-185

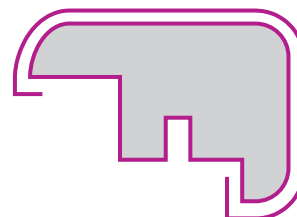

R-186

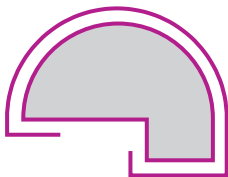

R-188

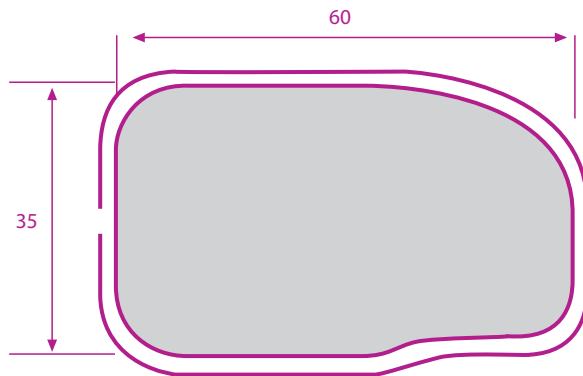

R-189

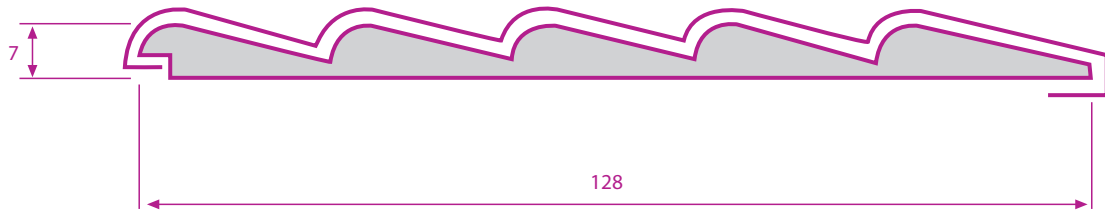

R-192

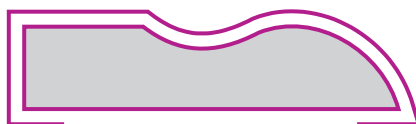

R-195

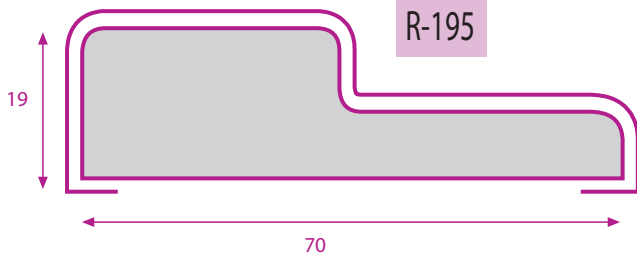

R-196

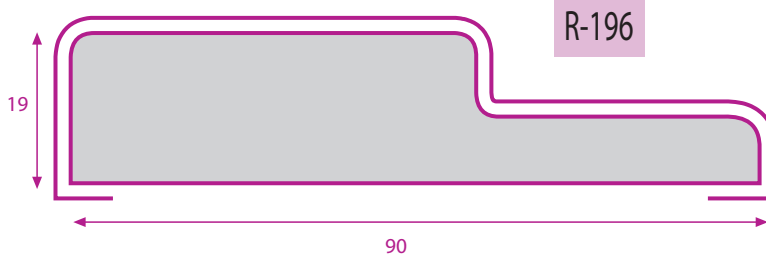

R-197

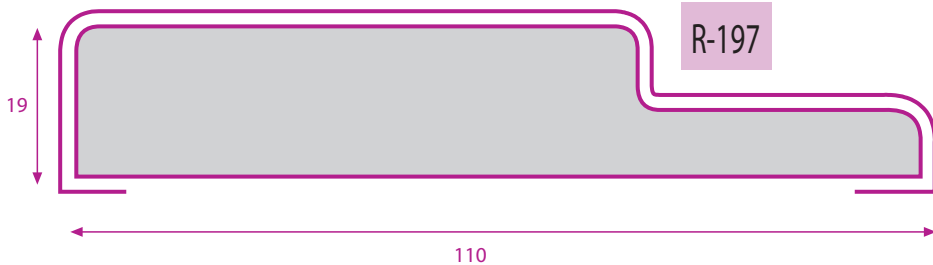

R-198

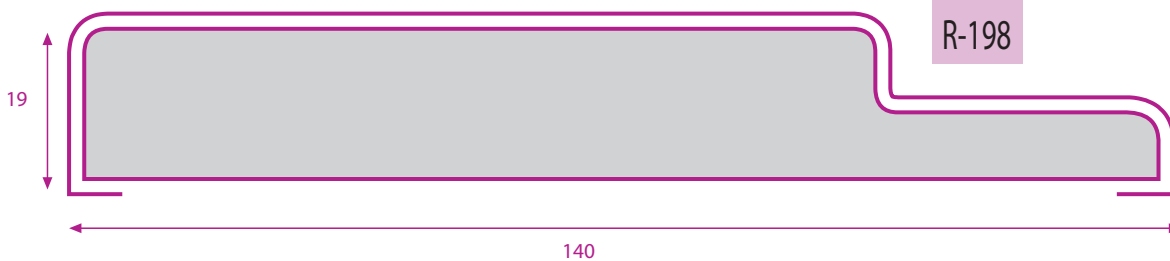



R-189



R-200



R-201

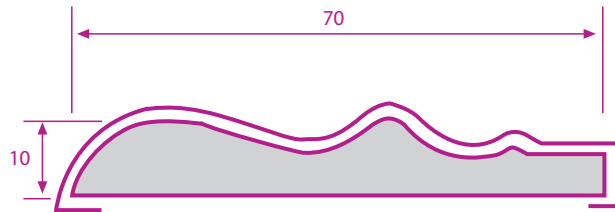

R-202

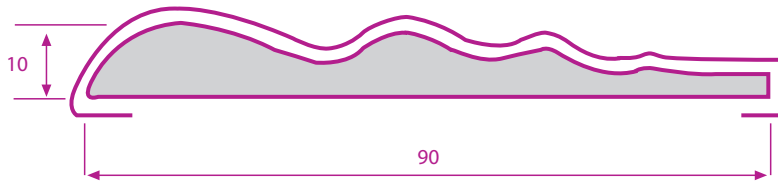

R-203

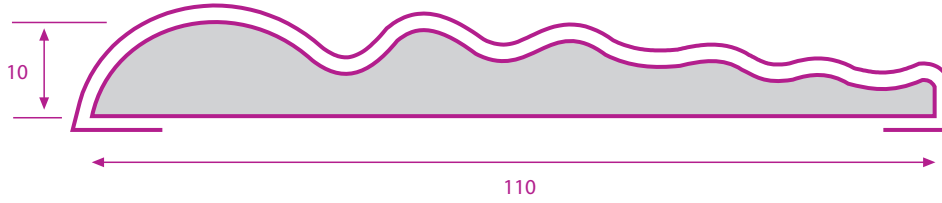

R-204



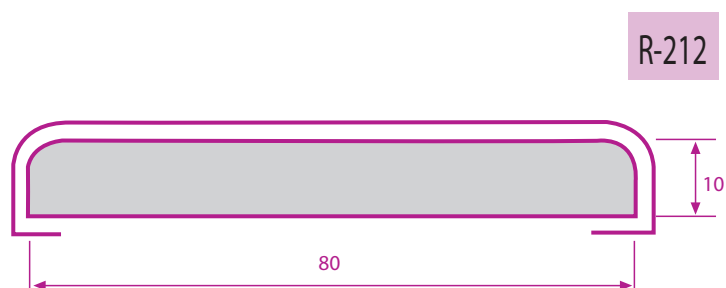
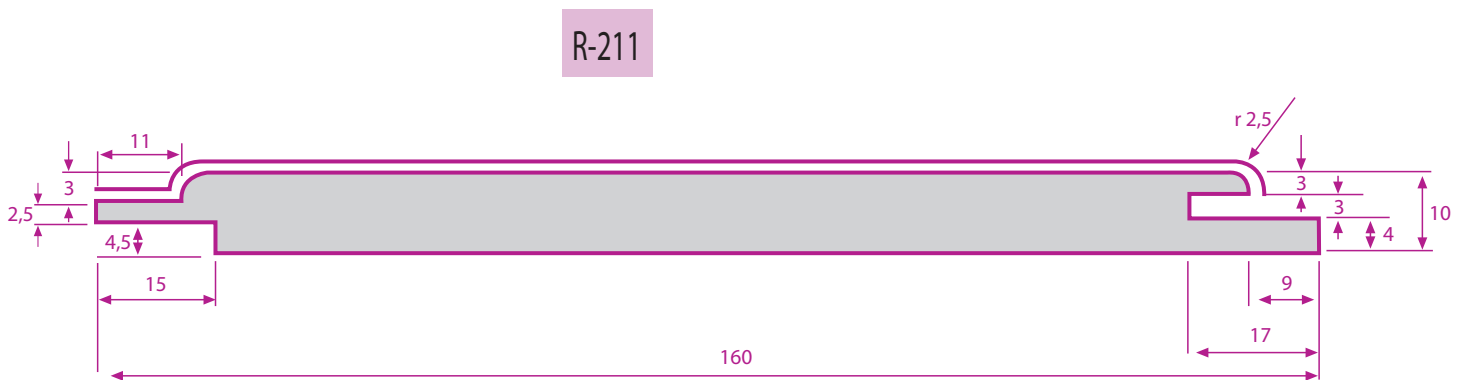
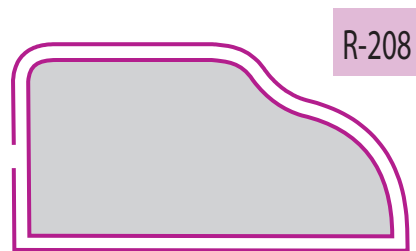
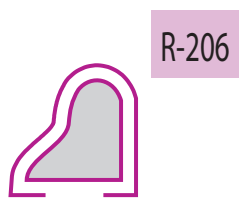
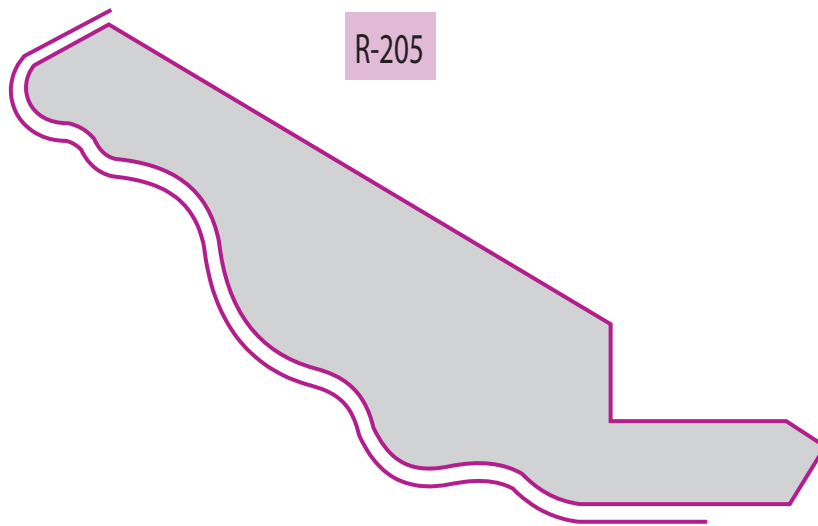

R-214

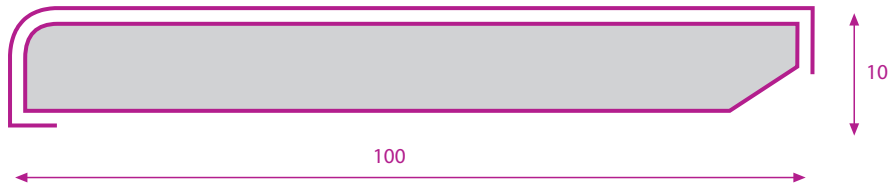

R-215

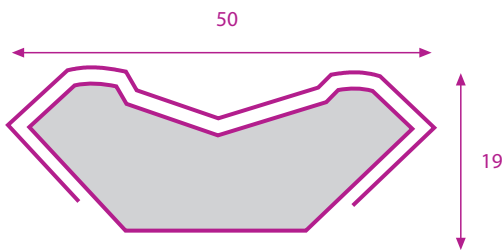

R-216

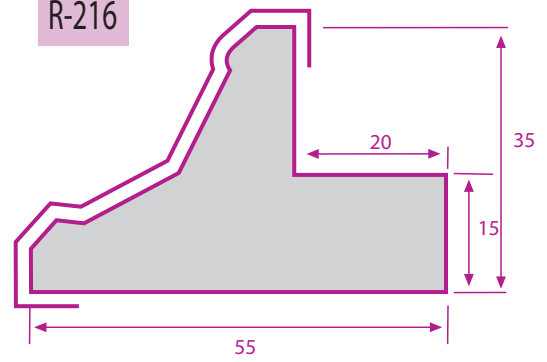

R-217

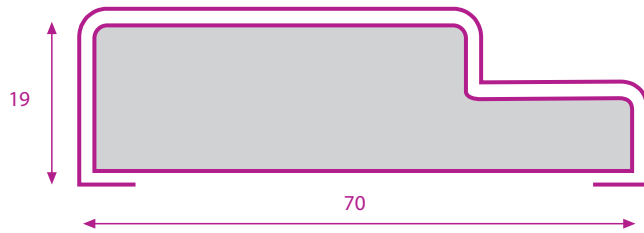

R-218

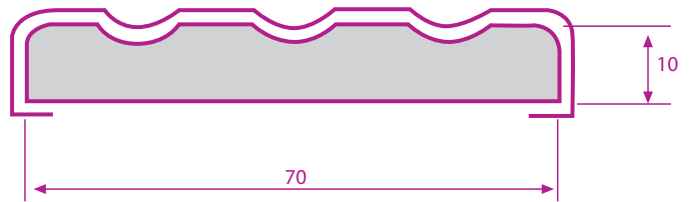

R-219

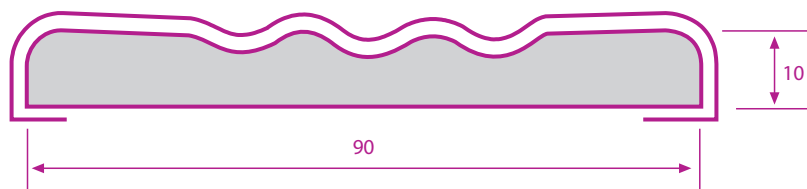

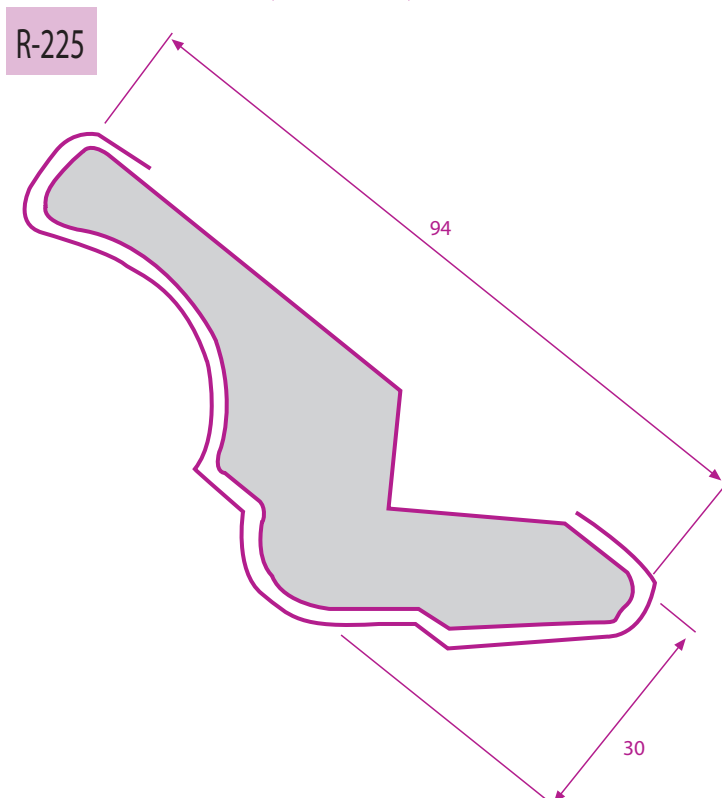
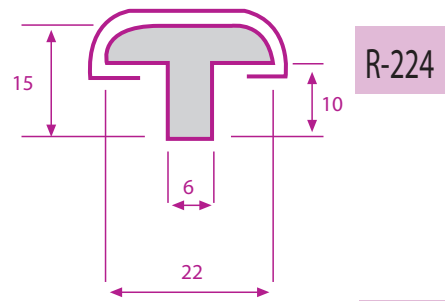
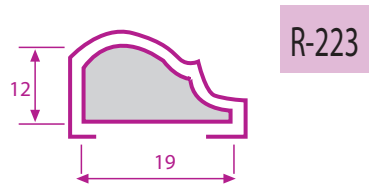
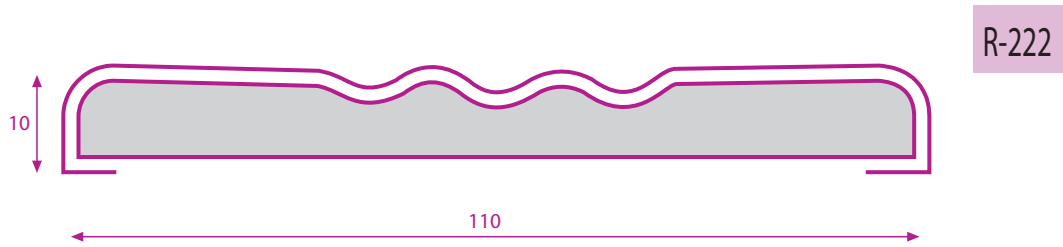
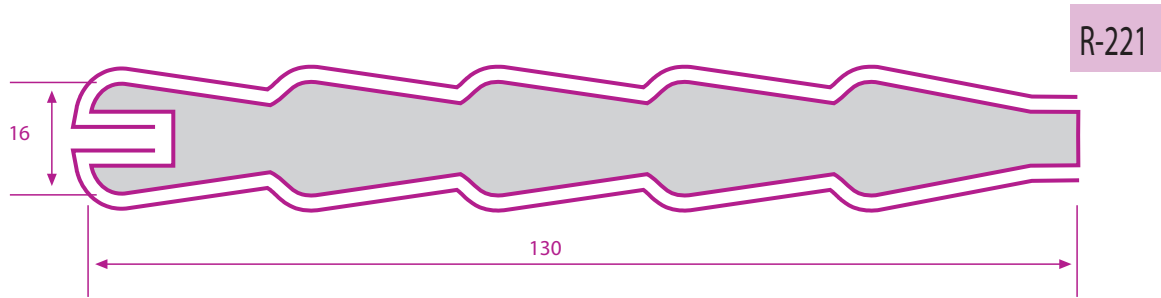
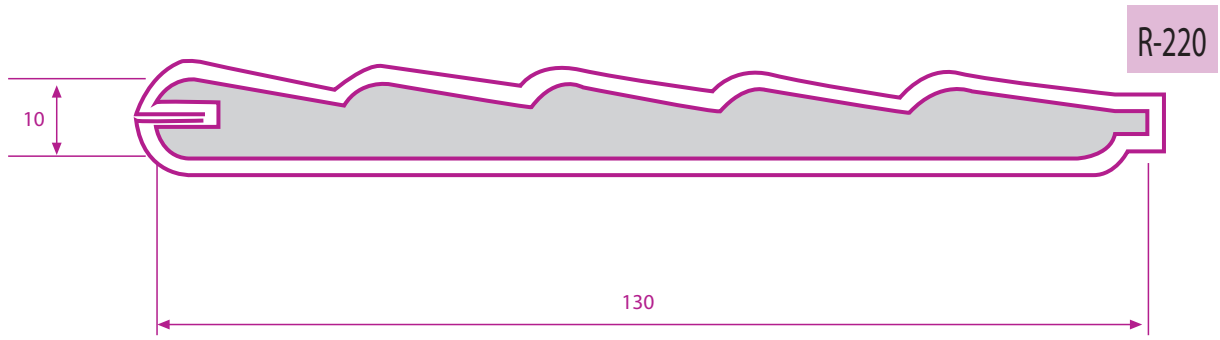

R-228

(L= 148)

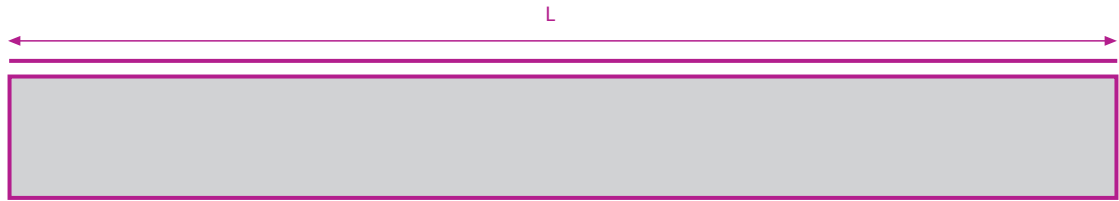

R-229

(L= 168)

R-230

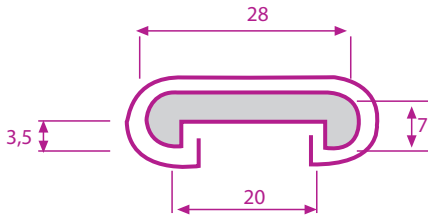

R-231

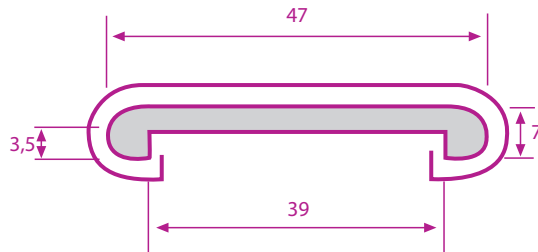

R-232

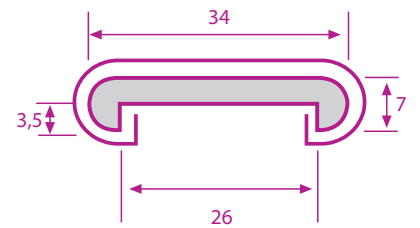

R-233

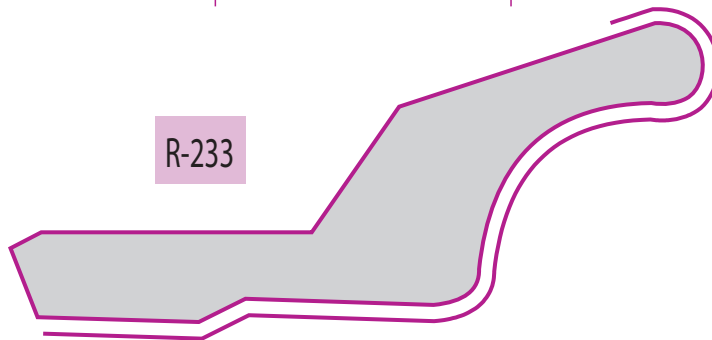

R-234

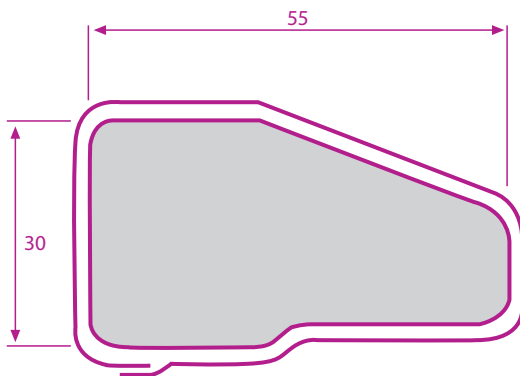

R-236

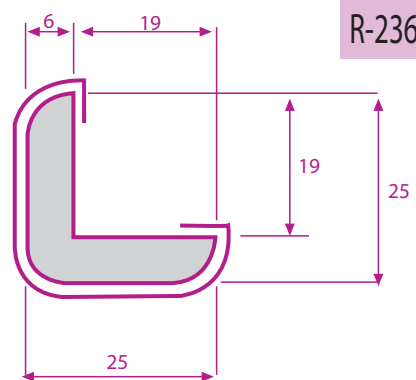

R-235

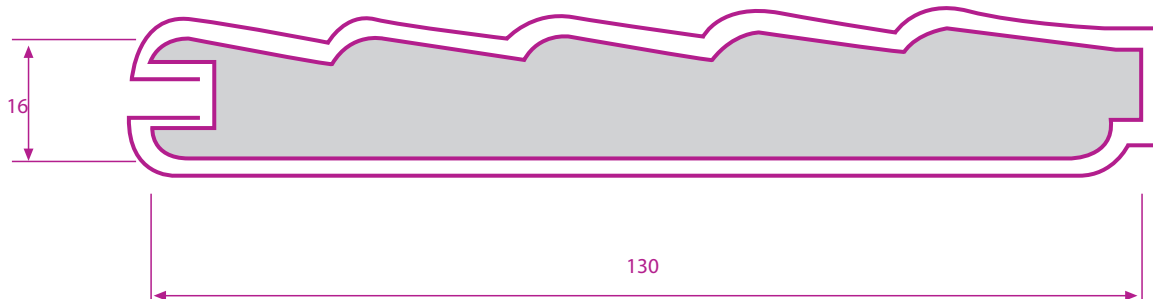

R-237

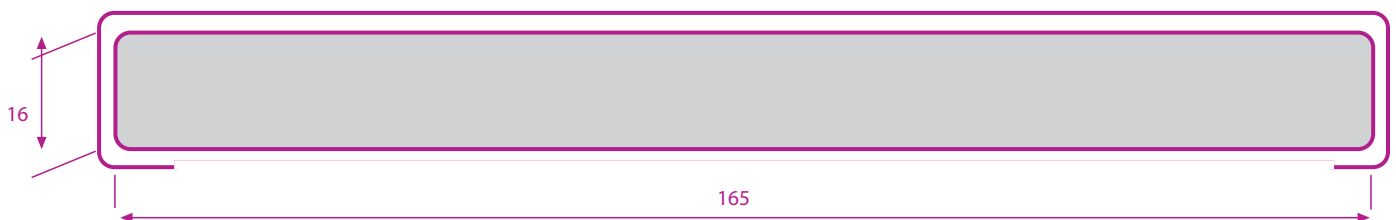

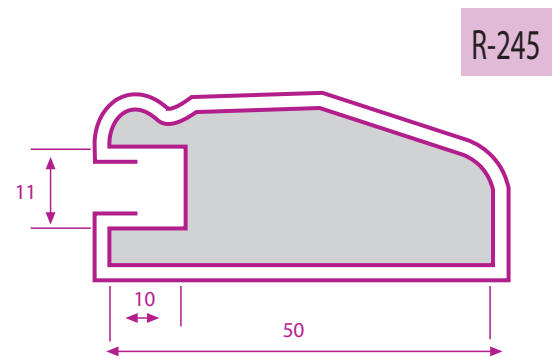
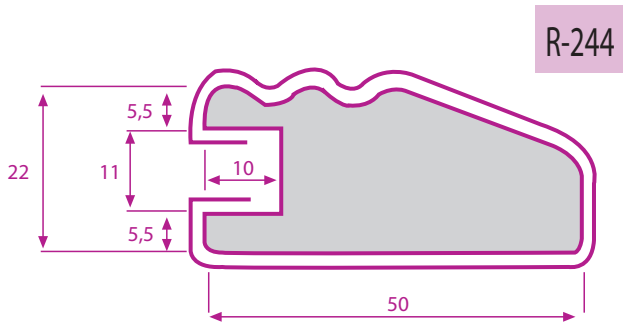
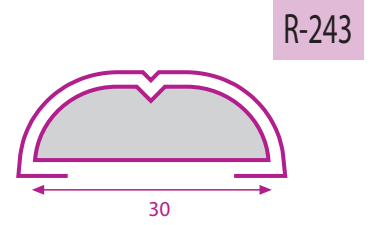
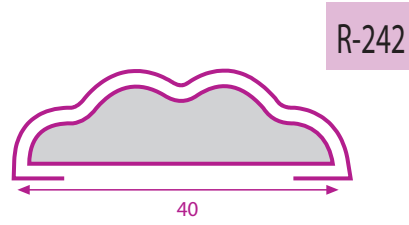
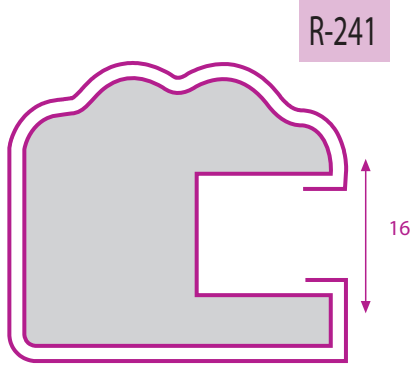
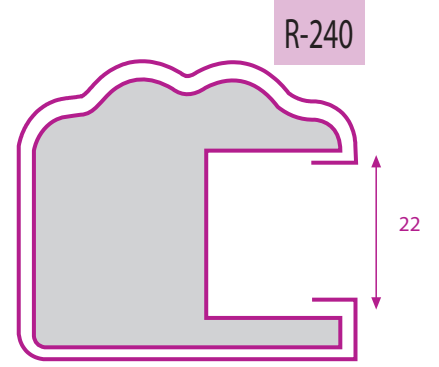
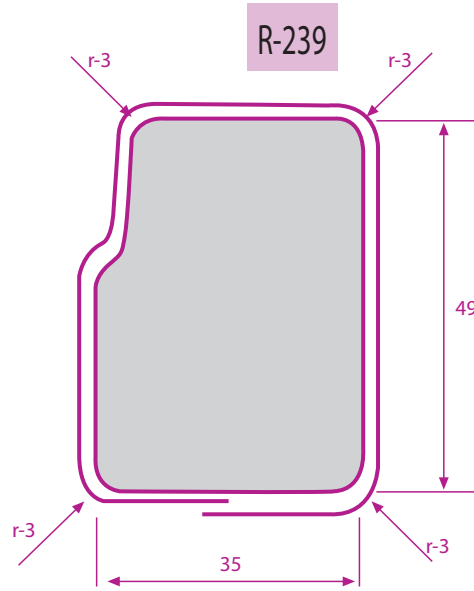
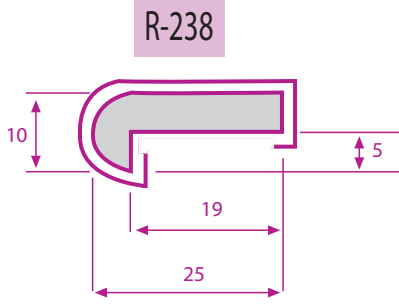

RANURA PARA TABLERO DE 10 mm.

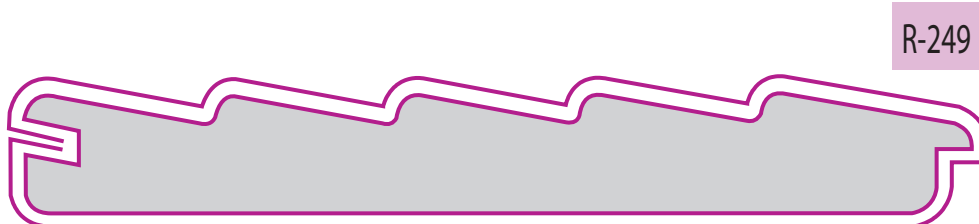
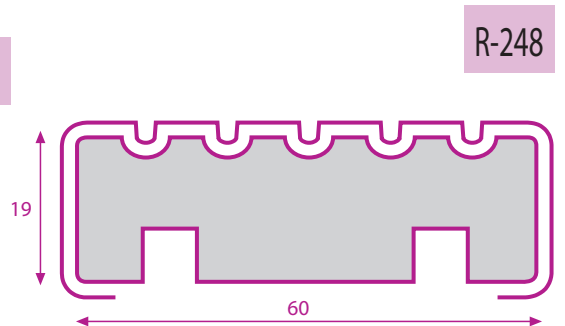
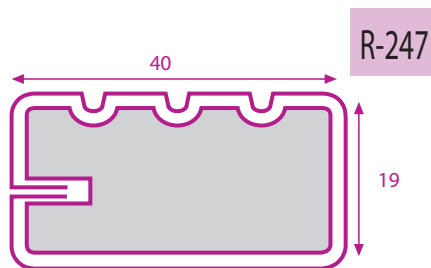
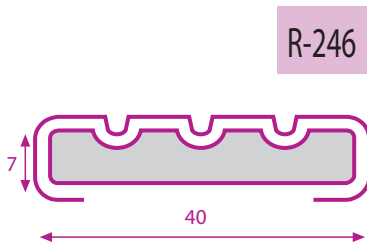

R-251

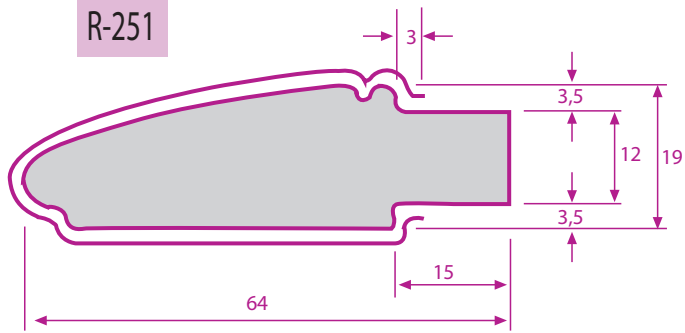

R-252

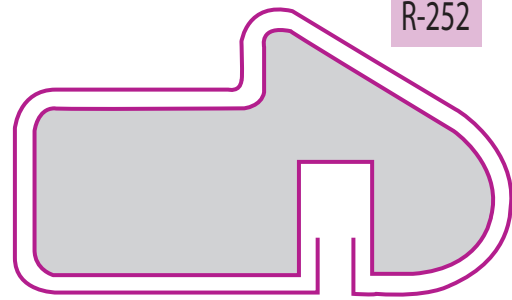

R-253



R-254

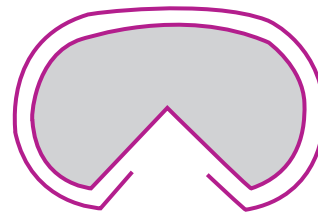

R-255

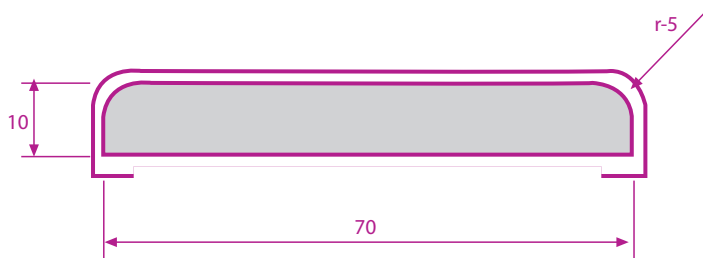

R-256

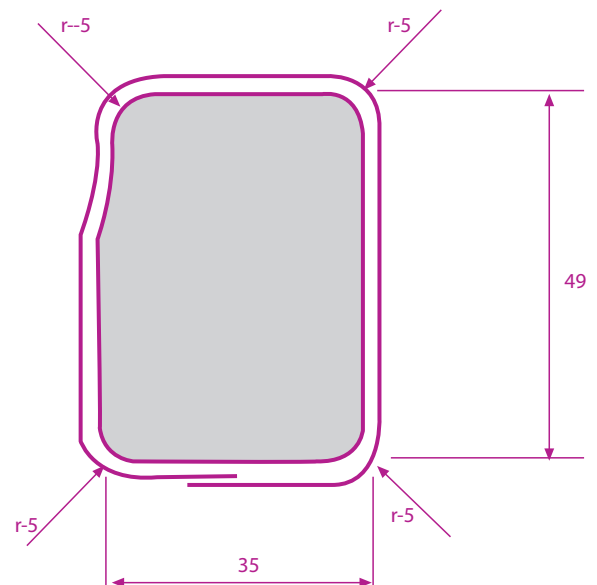

R-257

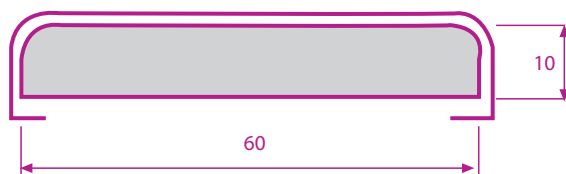

R-258

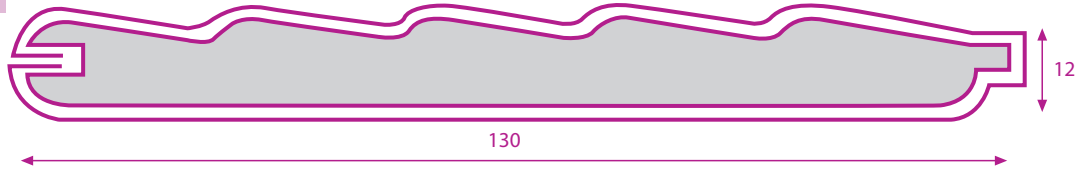

R-259

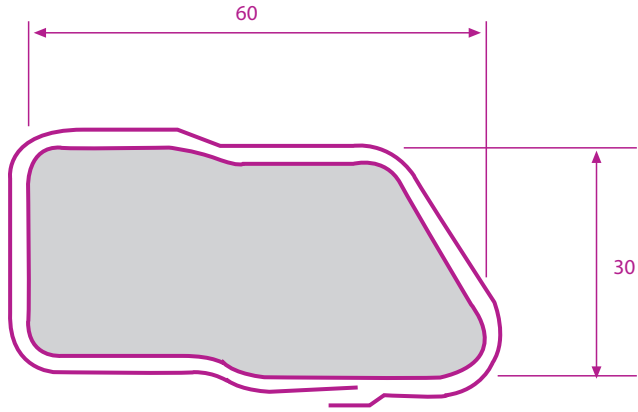

R-260

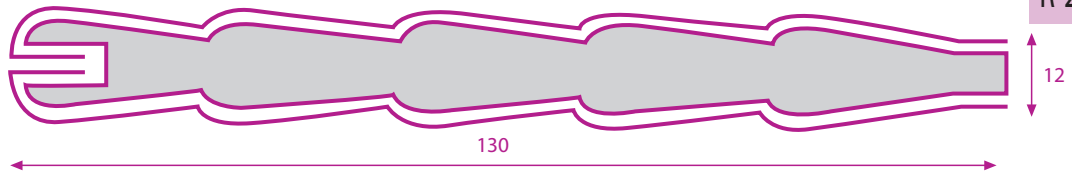

R-261

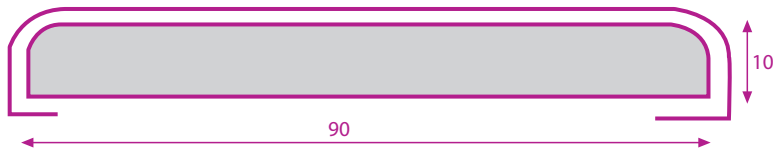

R-262

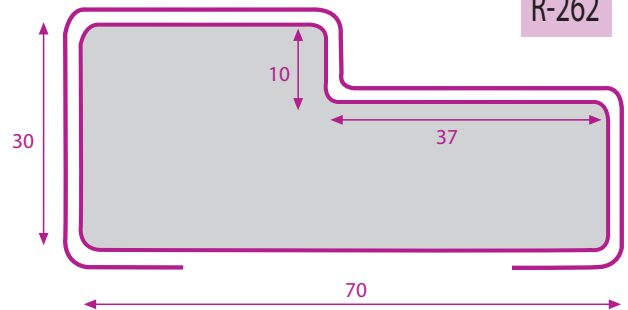

R-263

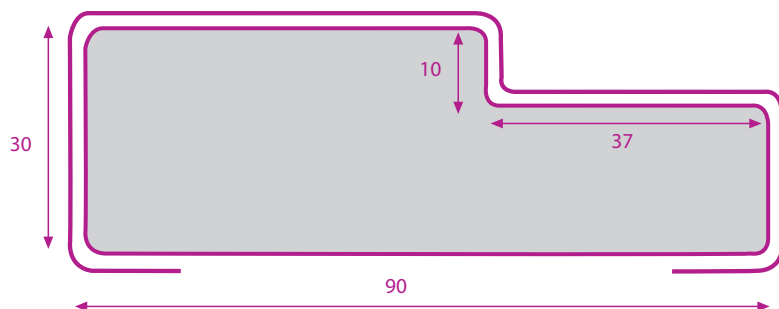



R-264

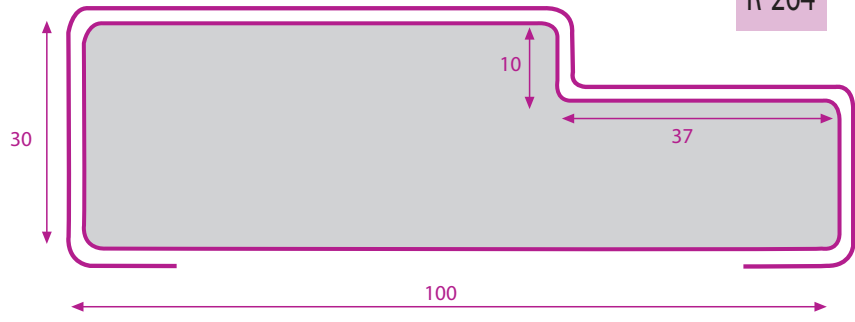

R-265

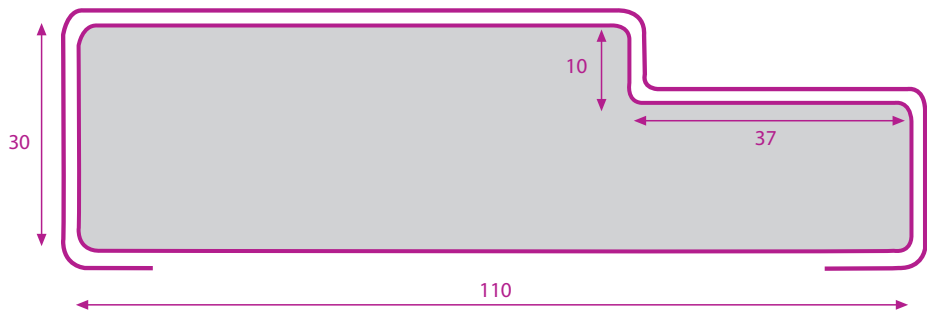

R-266

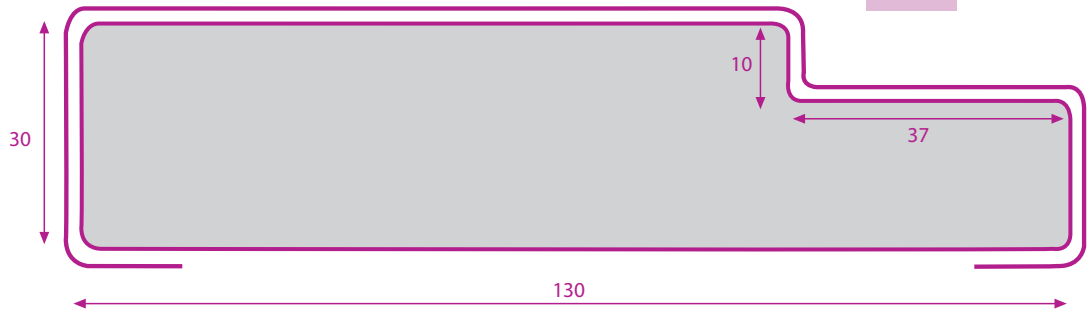

R-267

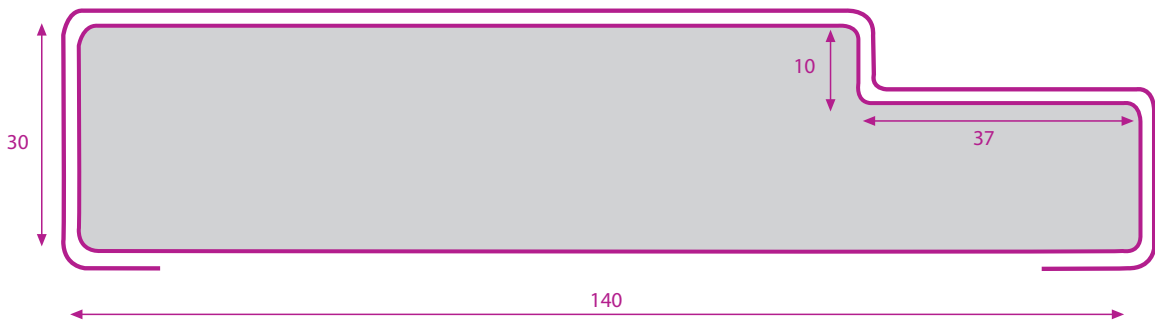

R-268

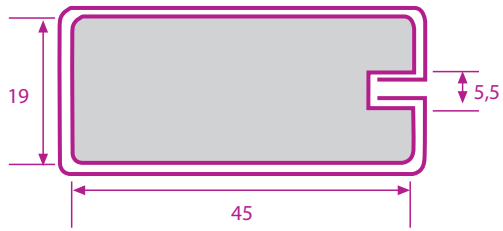

R-269

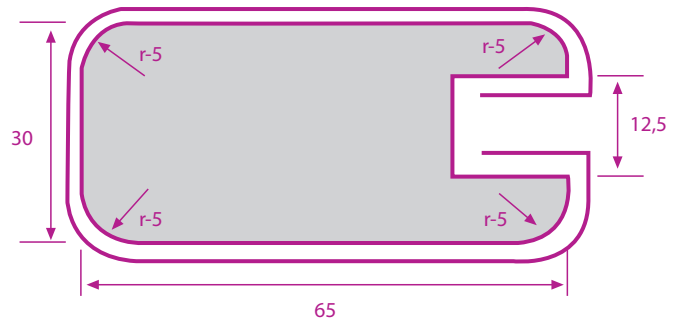

R-270

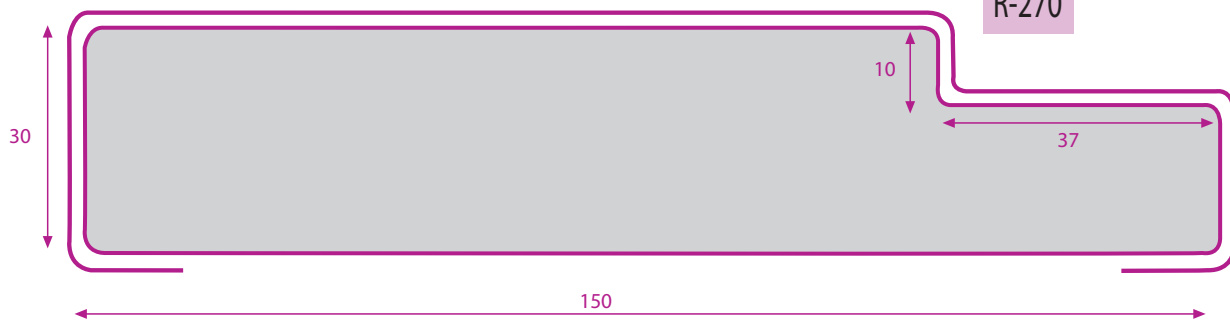

R-271

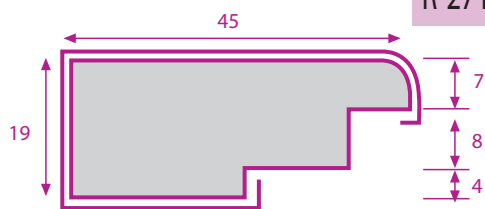

R-272

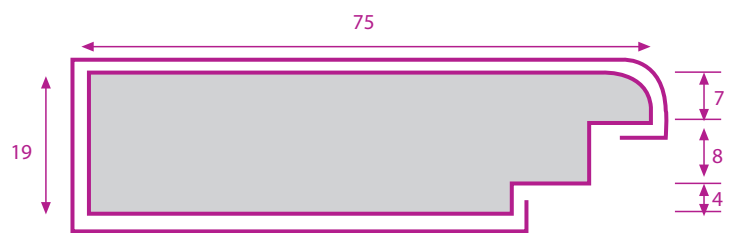

R-273

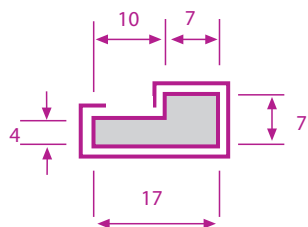

R-274

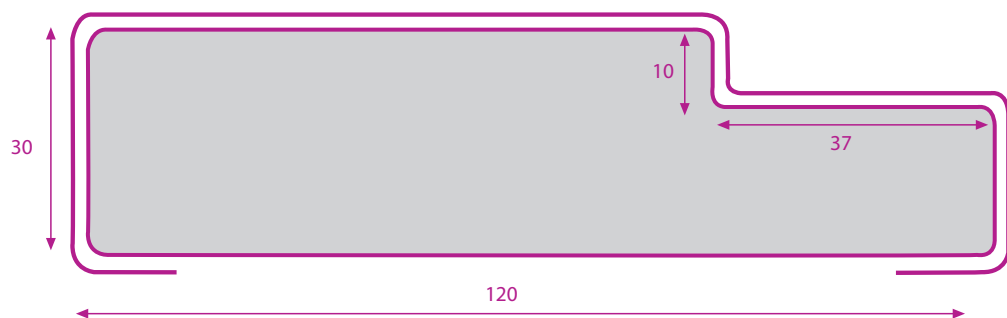

R-275

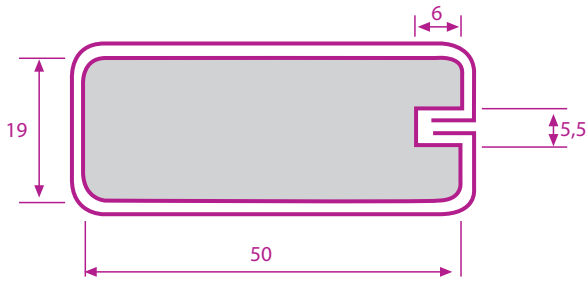

R-276

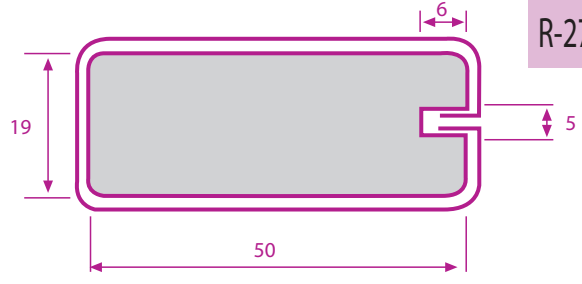

R-277

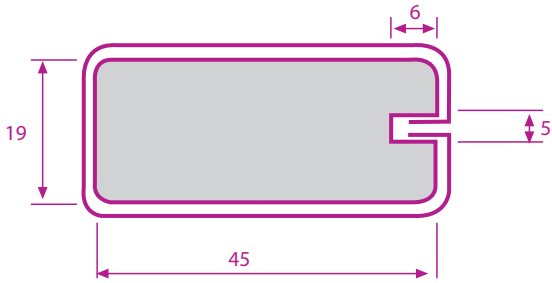

R-279



R-281

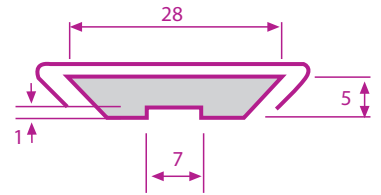

R-278

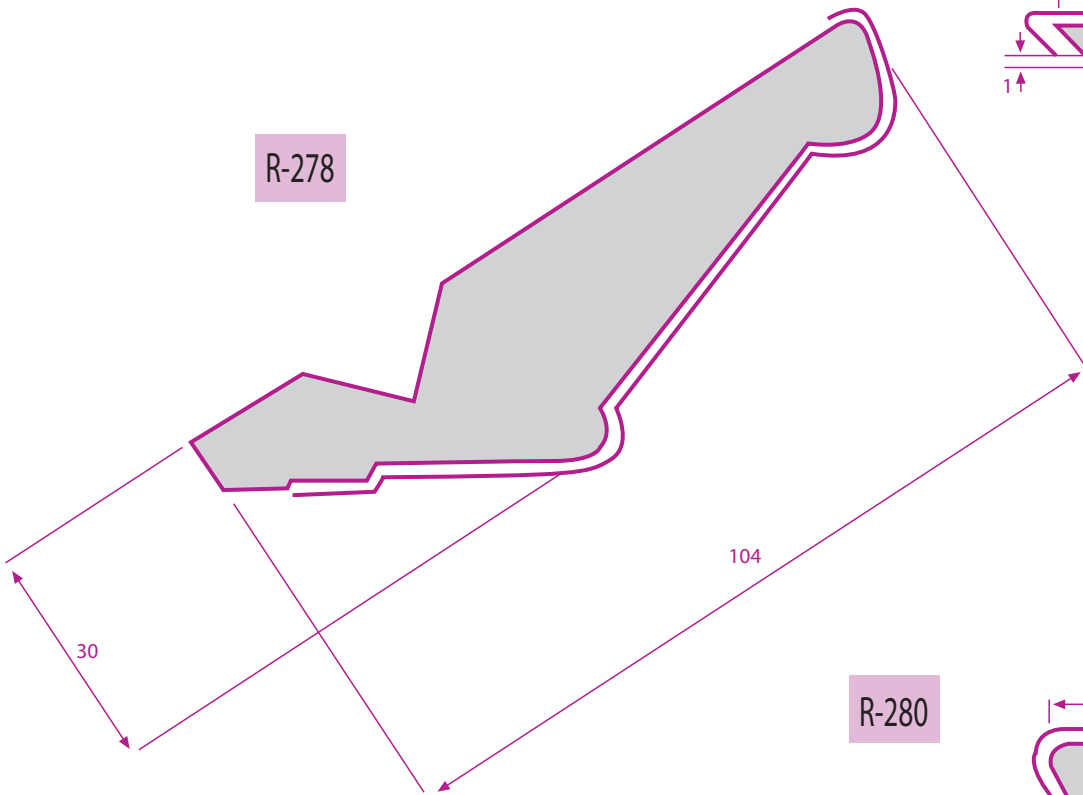

R-280

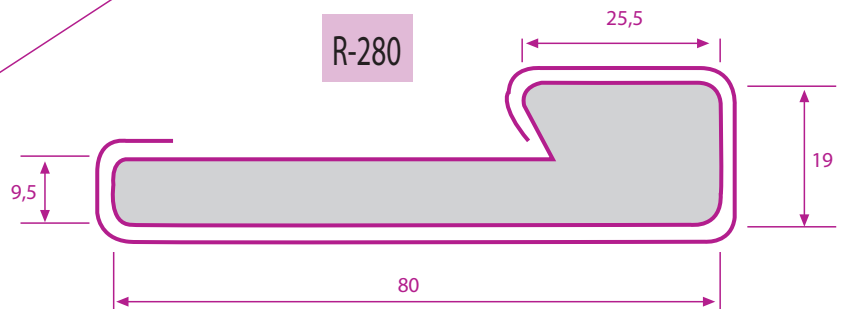

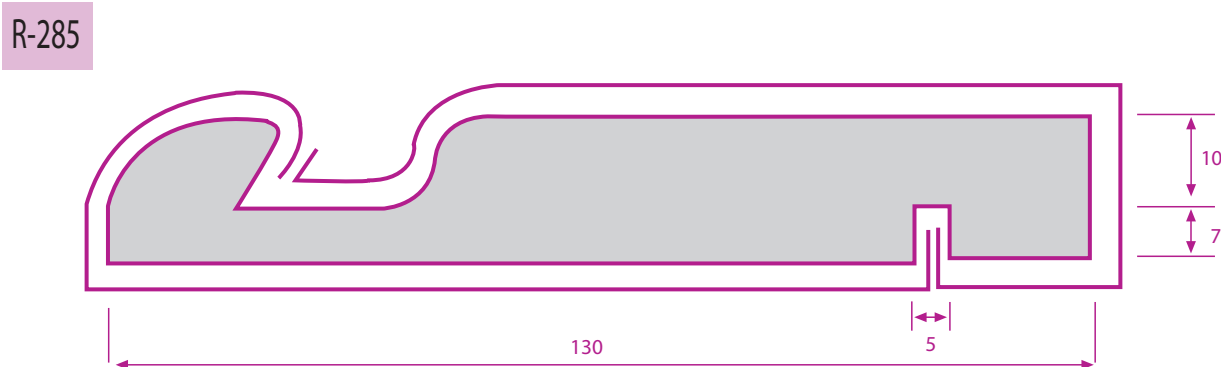
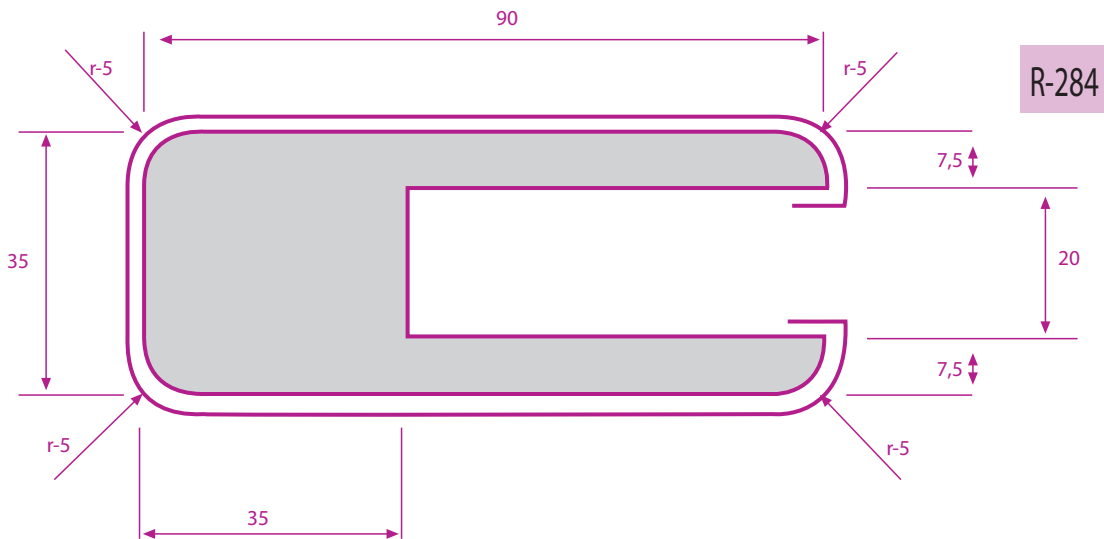
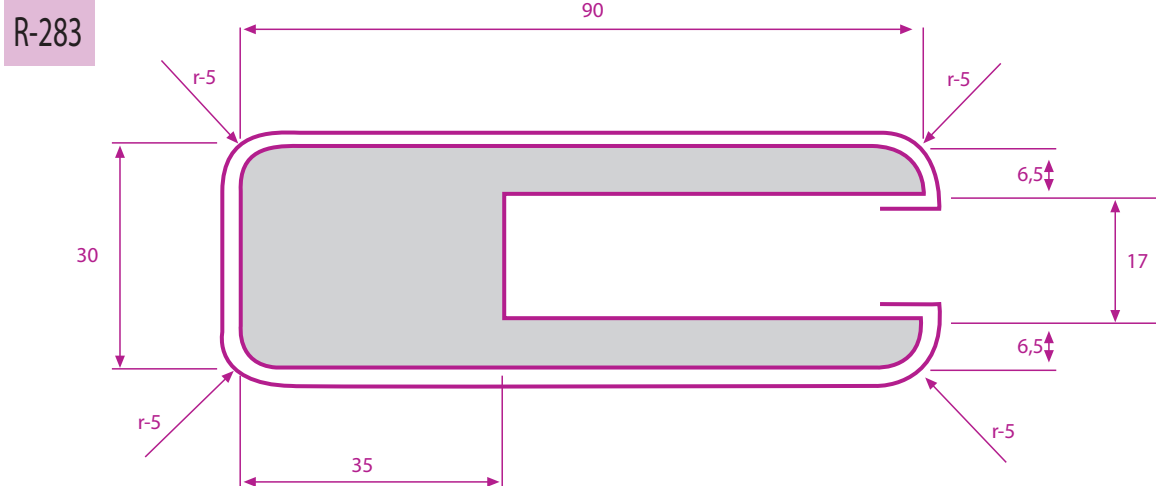
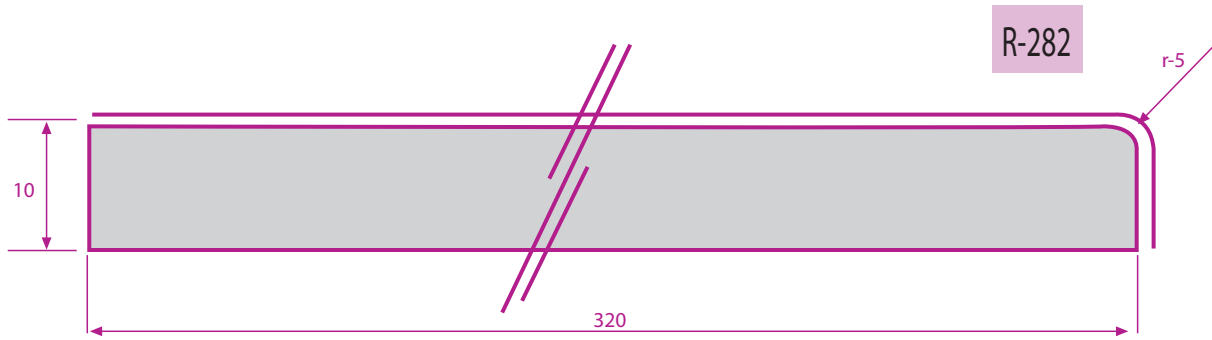

R-286

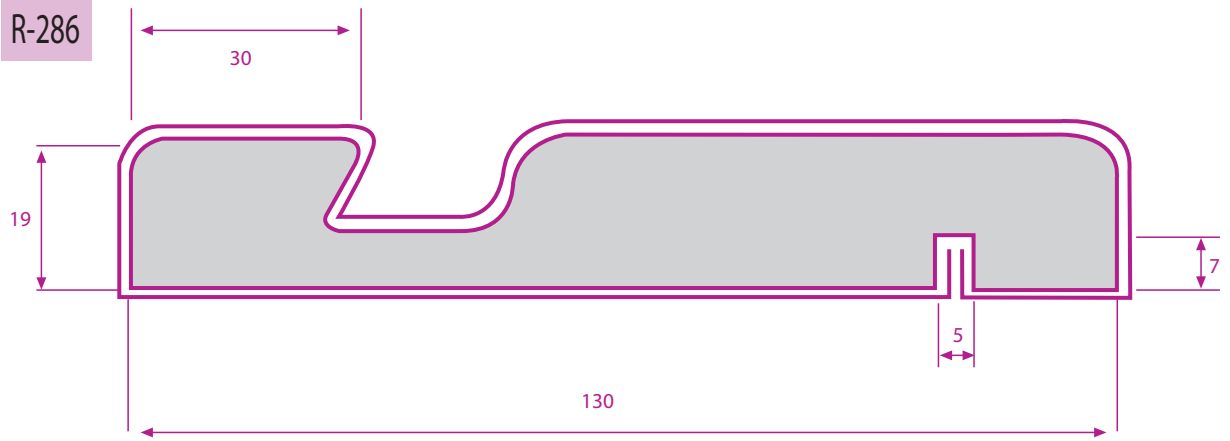

R-287

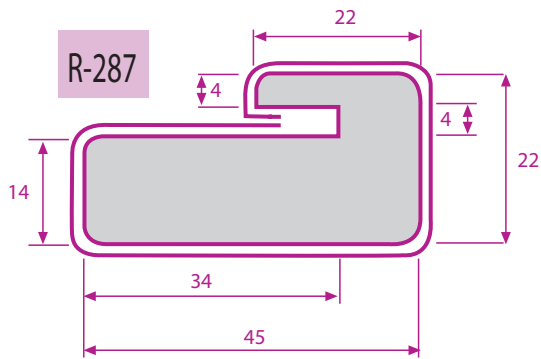

R-288

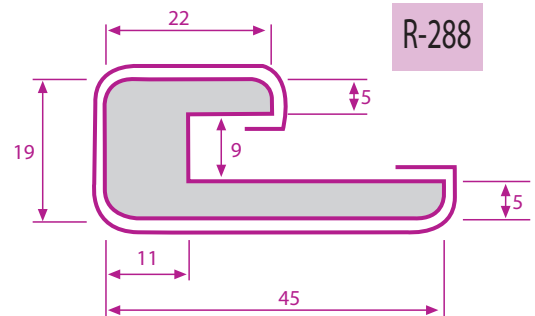

R-289

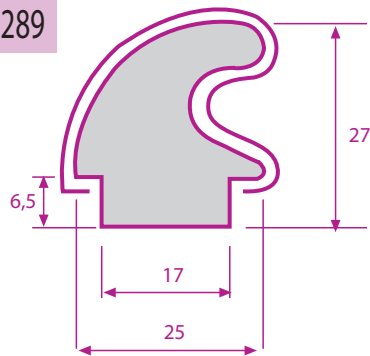

R-290

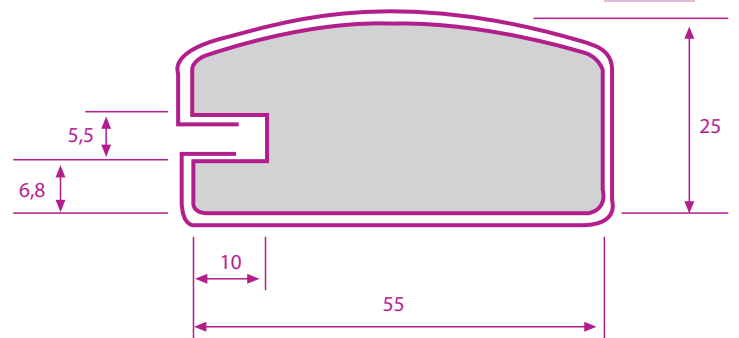

R-291

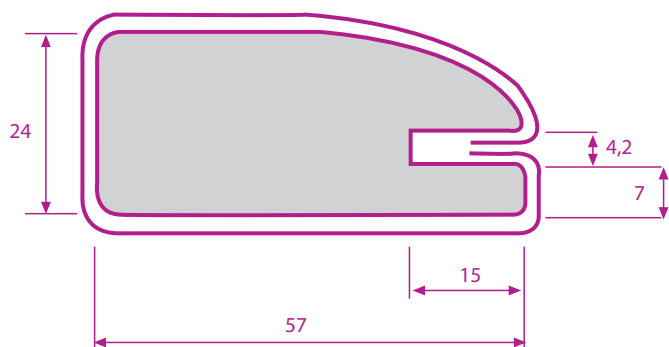

R-292

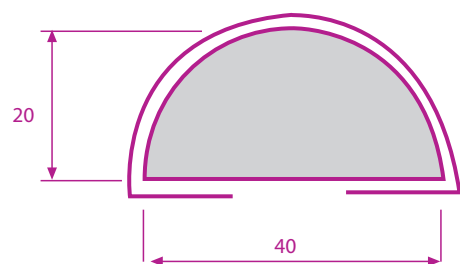

R-293

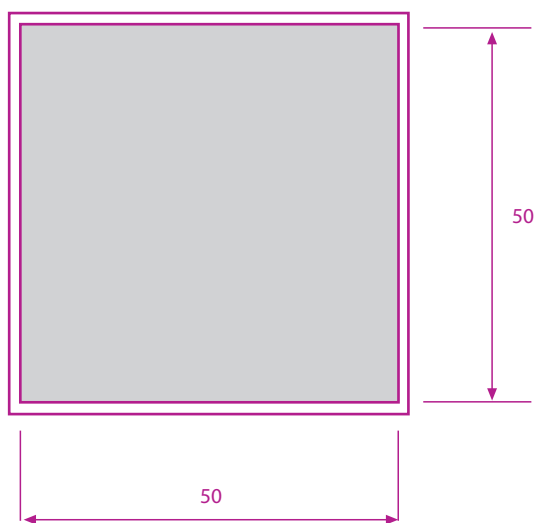

R-294

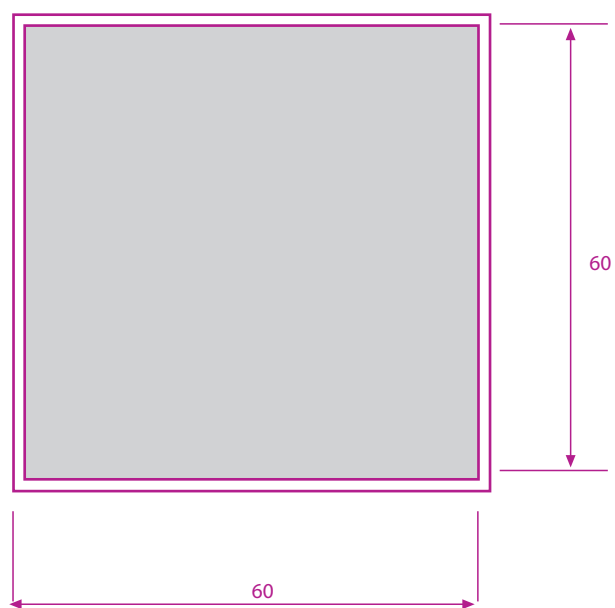

R-295

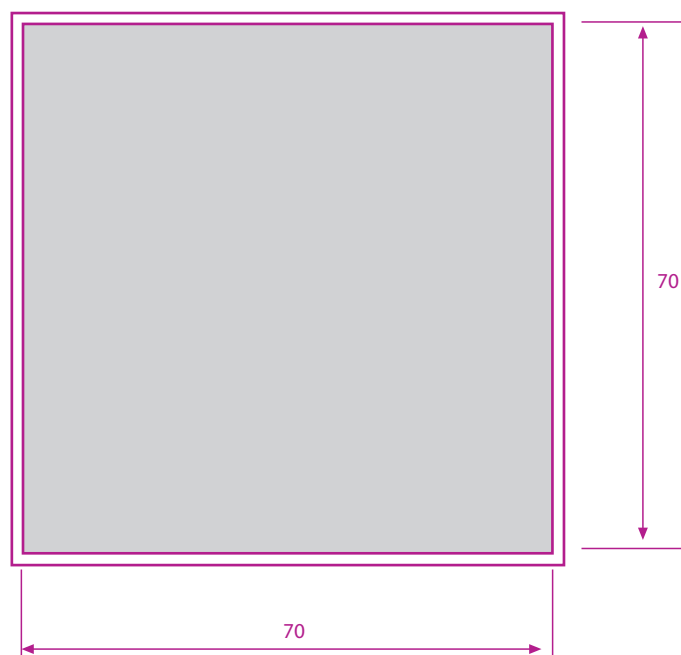

R-296

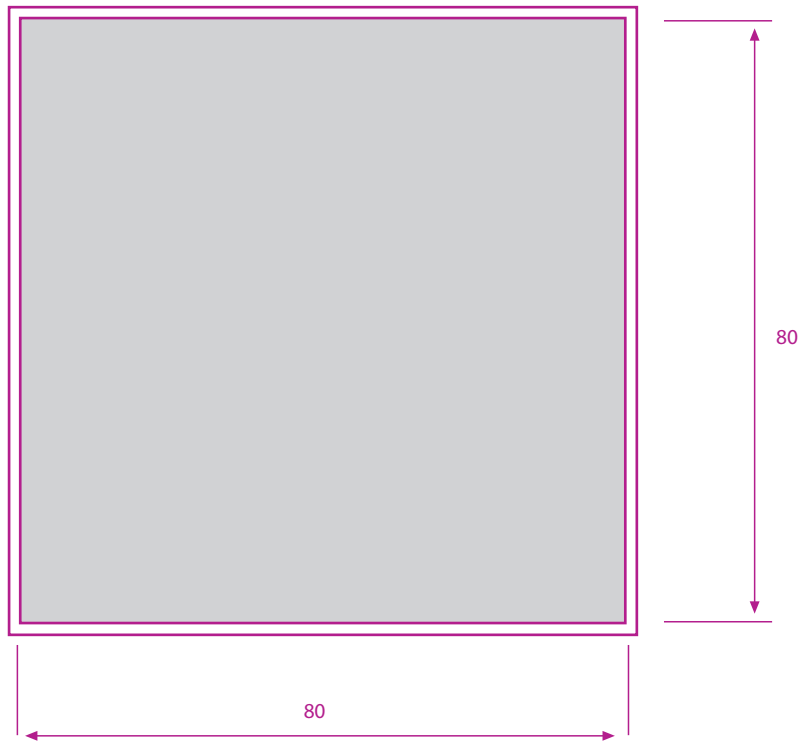

R-297

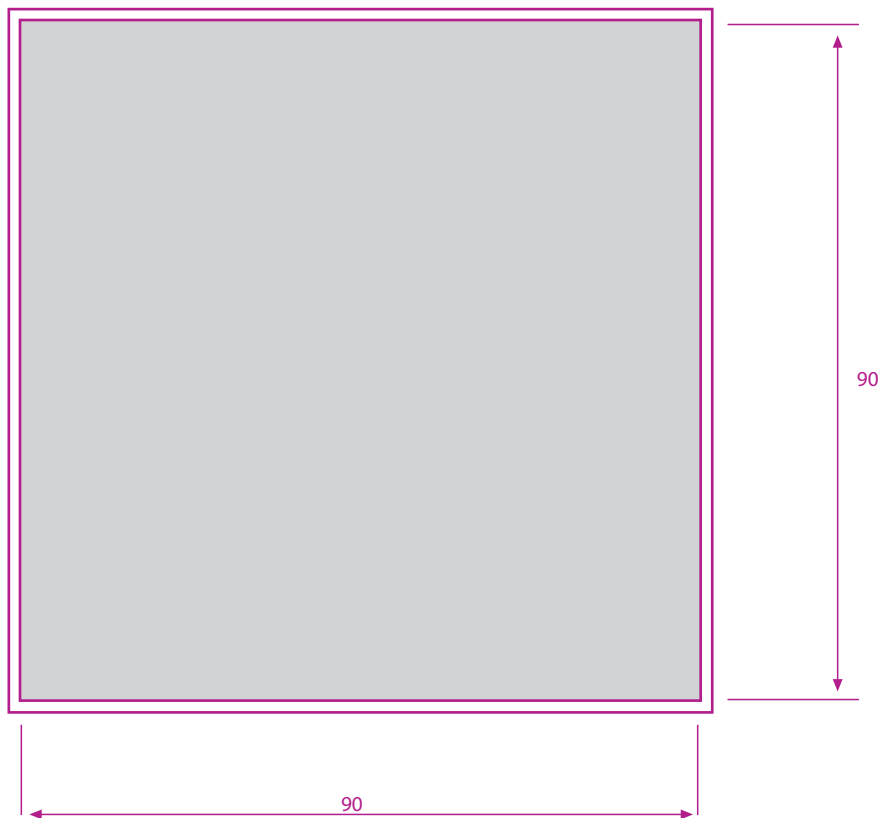

R-298

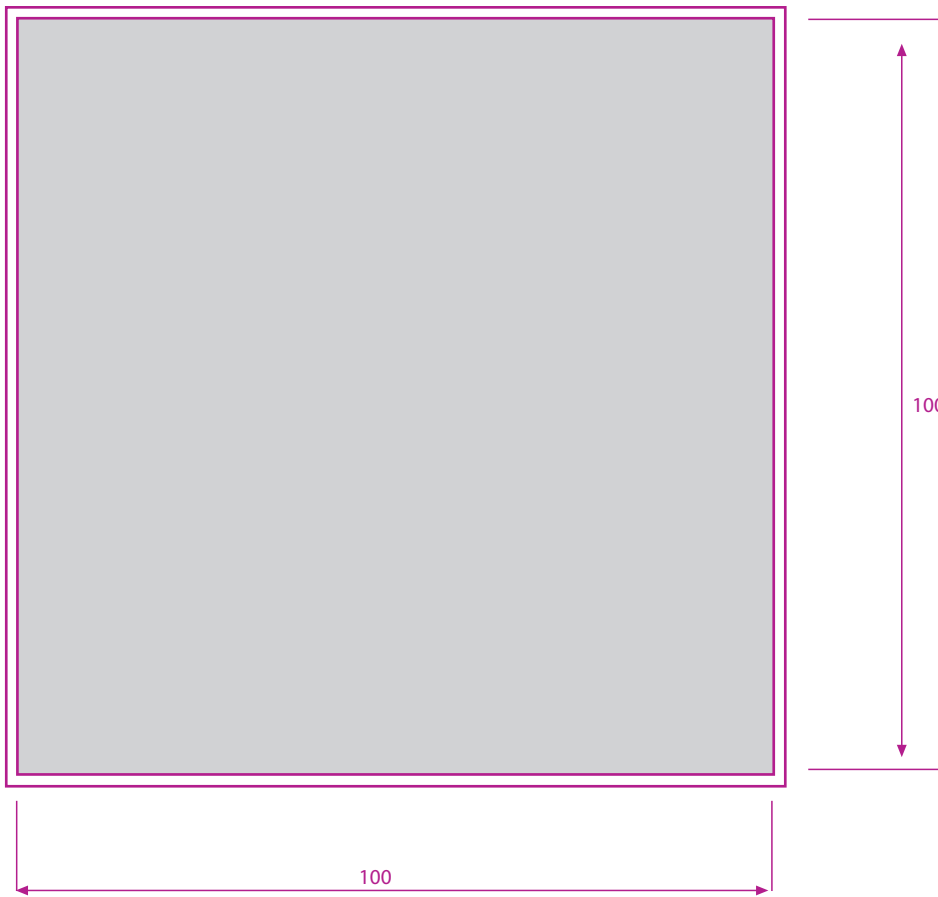

R-299

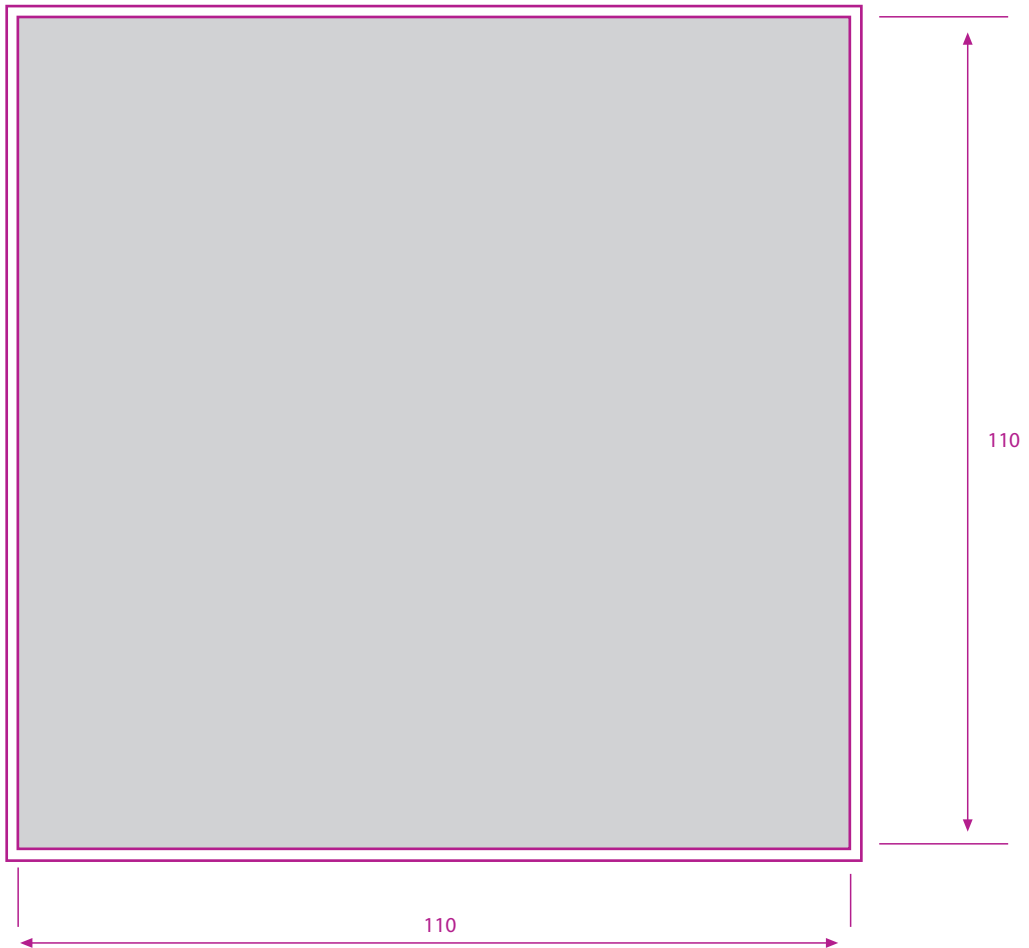



R-300

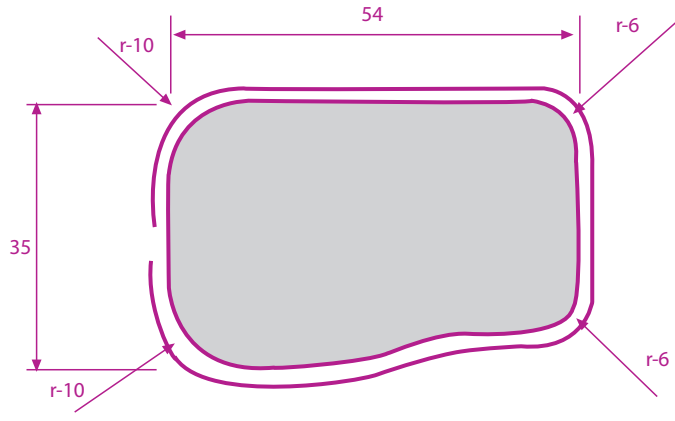

R-301

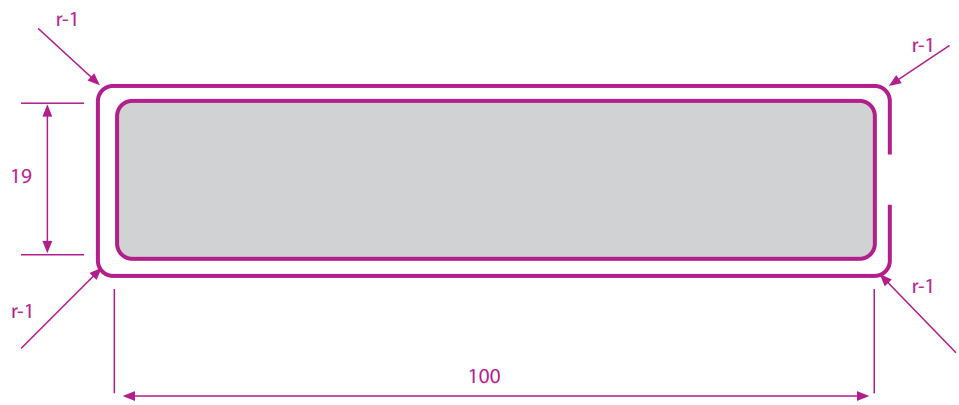

R-302

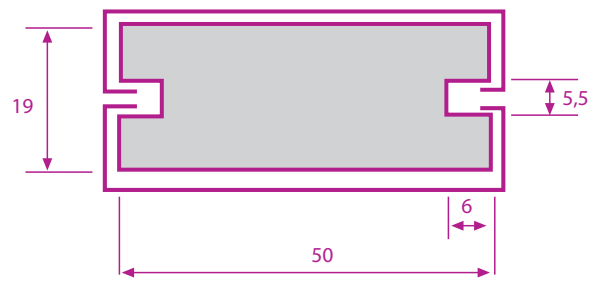

R-303

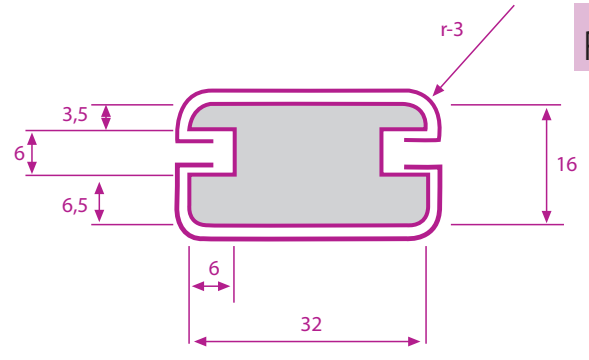

R-304

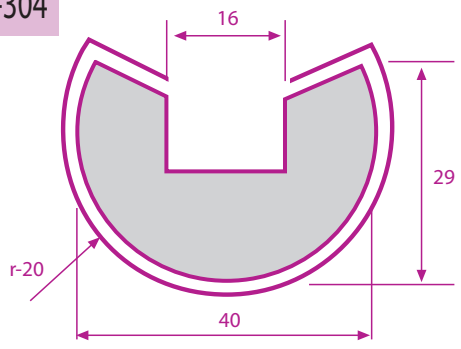

R-305

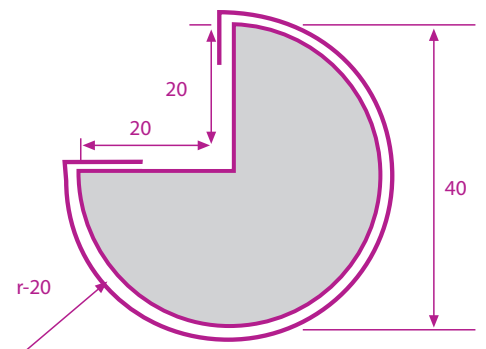

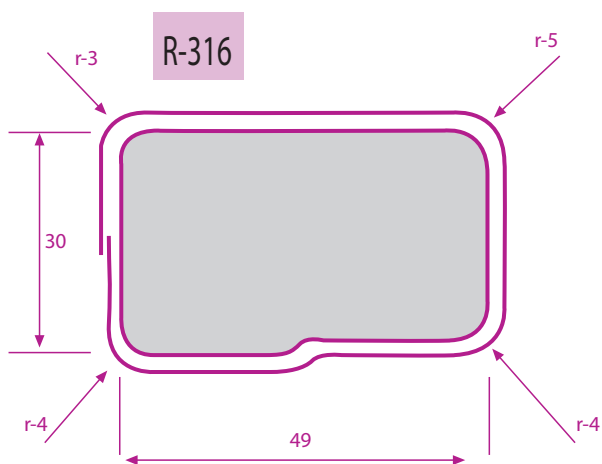
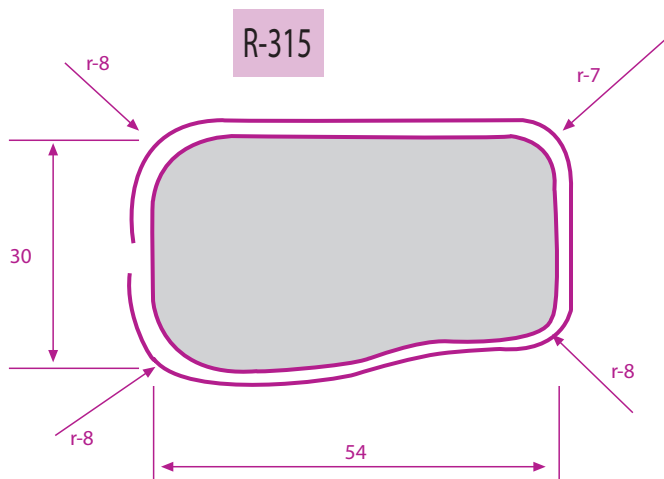
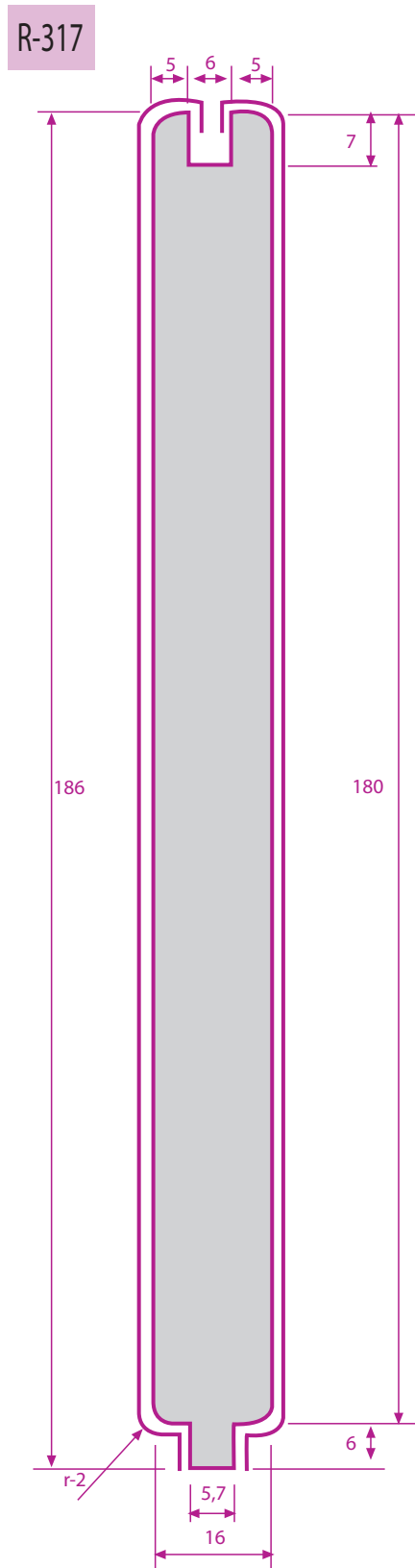
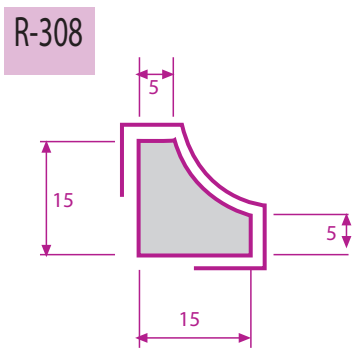
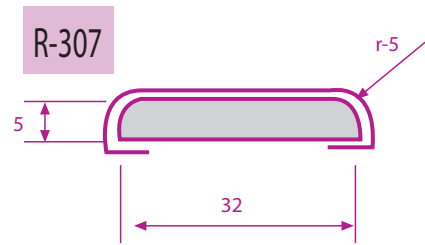
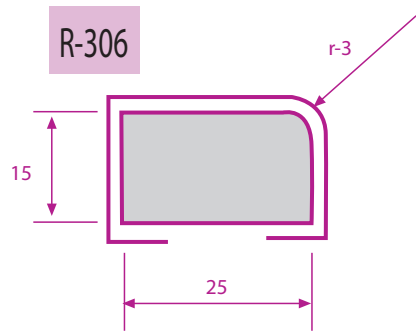

R-318

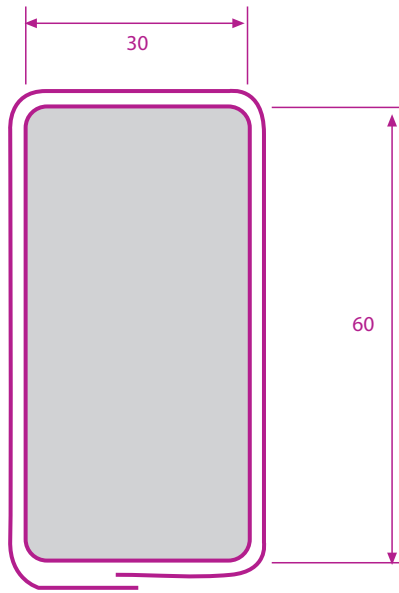

R-319

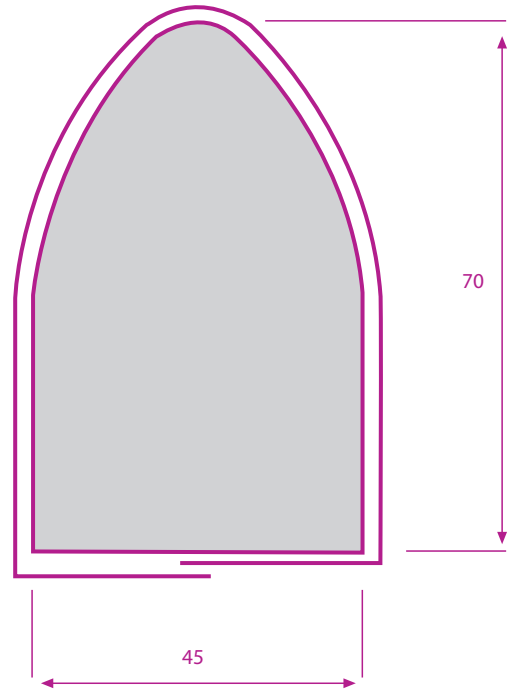

R-320

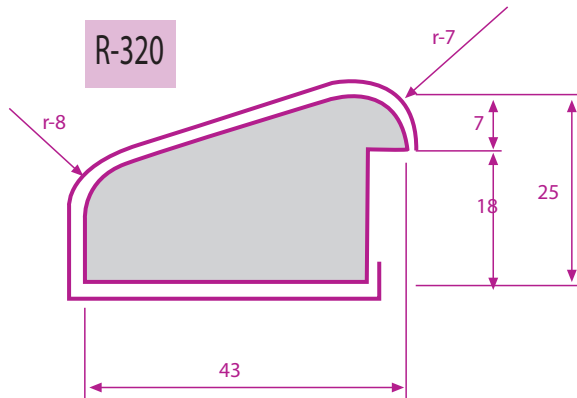

R-321

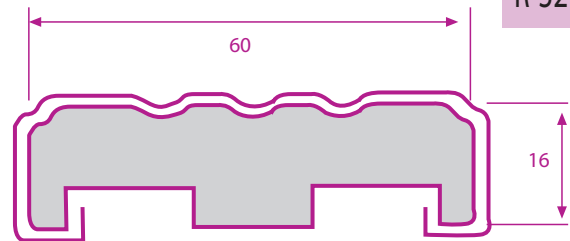

R-322

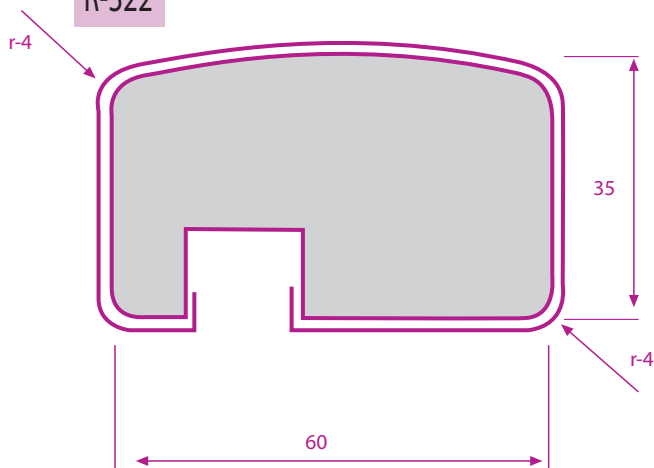

R-323

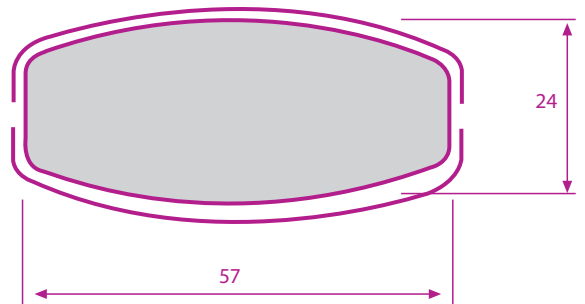

R-324

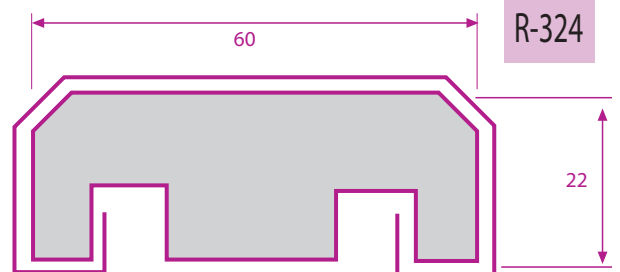

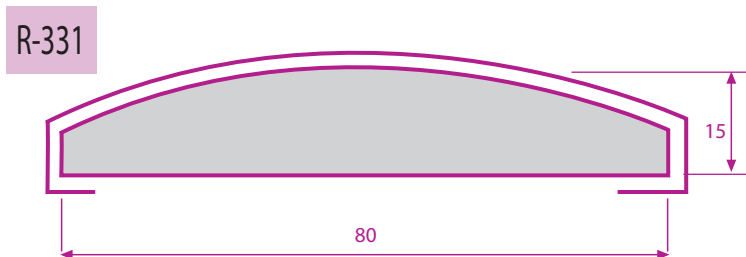
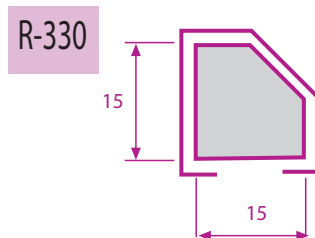
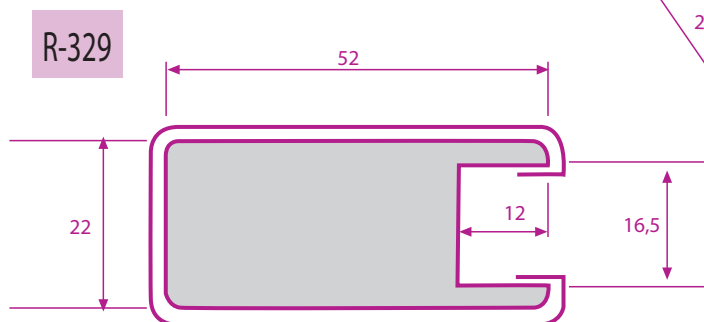
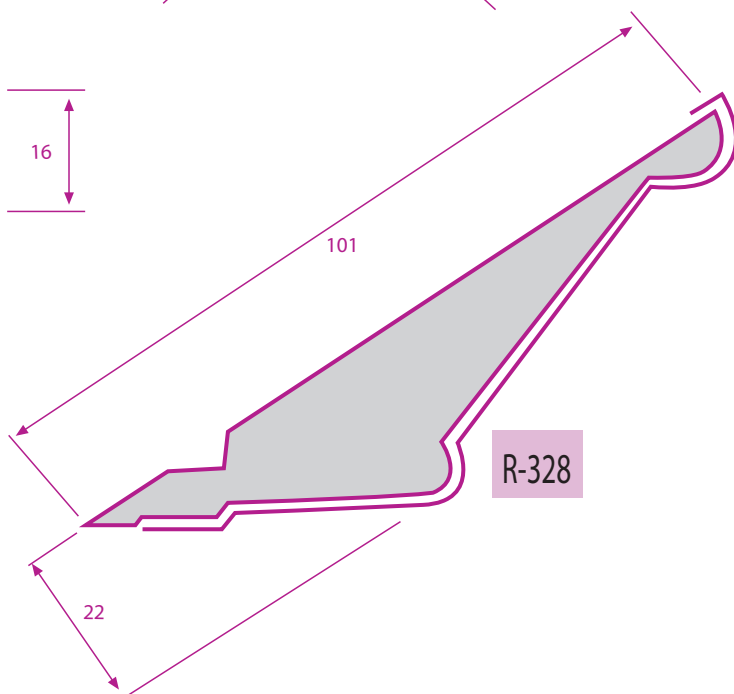
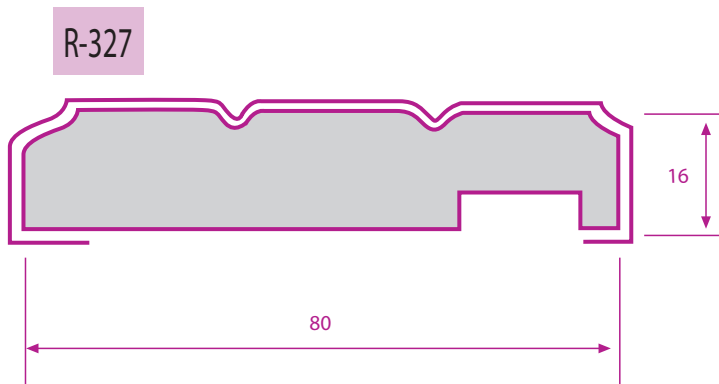
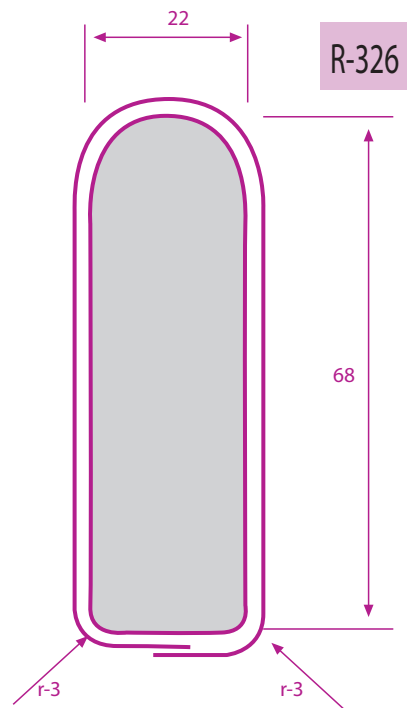
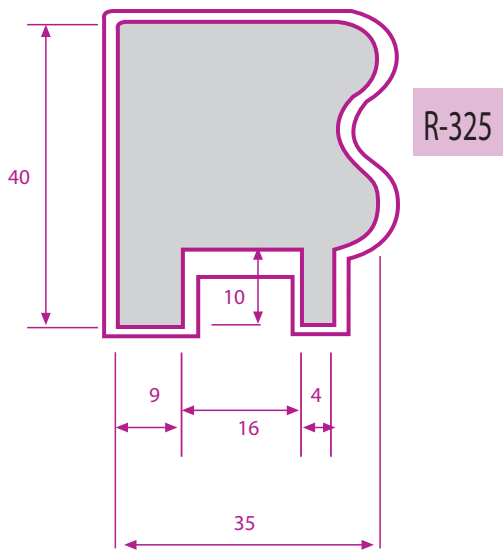

R-332

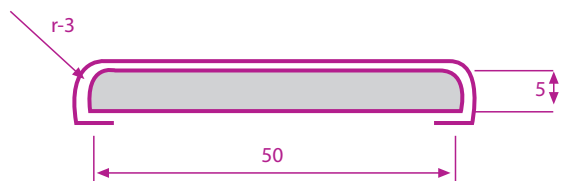

R-334

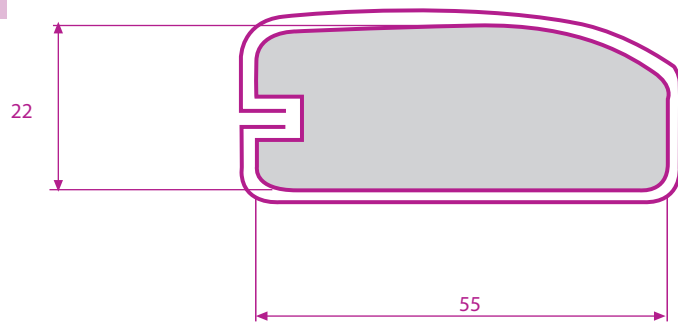

R-335

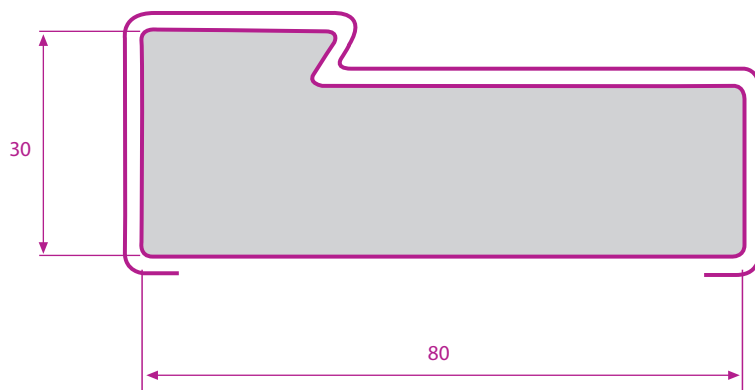

R-336

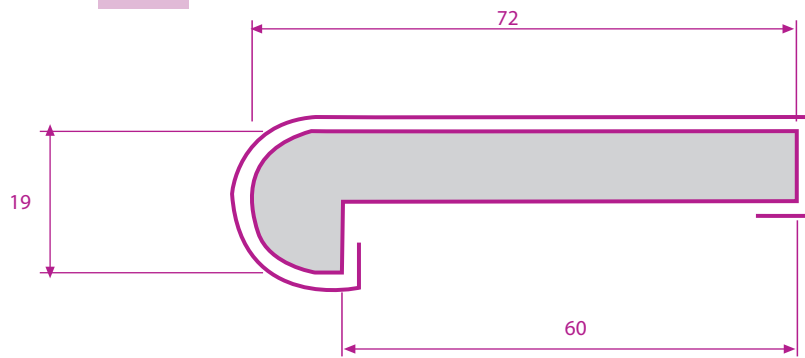

R-337

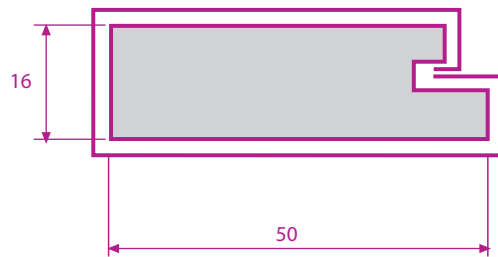

R-338

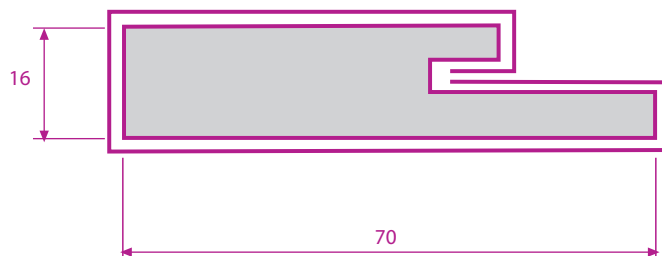

R-339



R-340

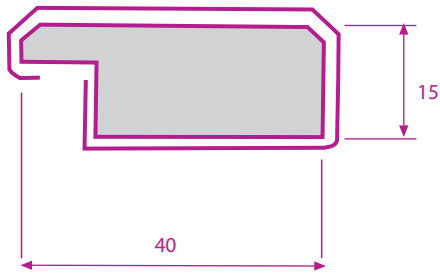

R-341

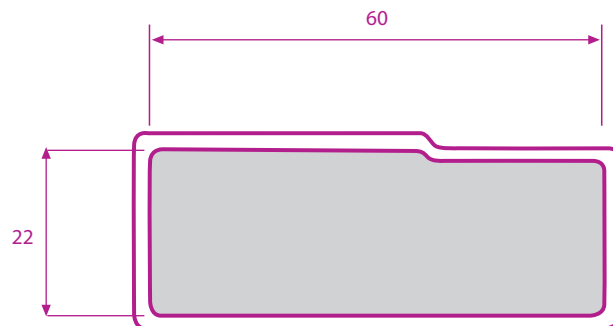

R-342

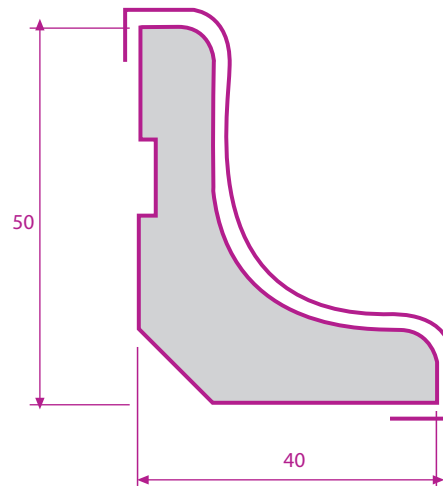

R-343

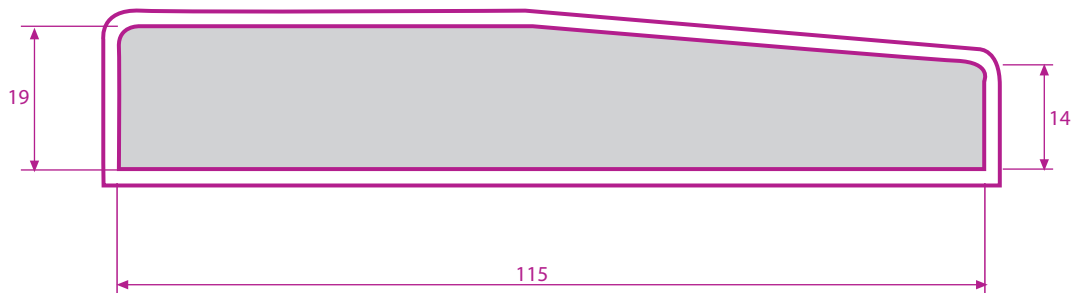

R-344

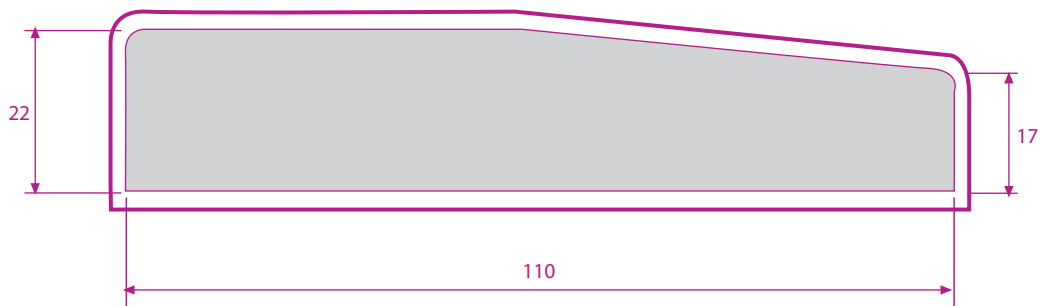



R-345

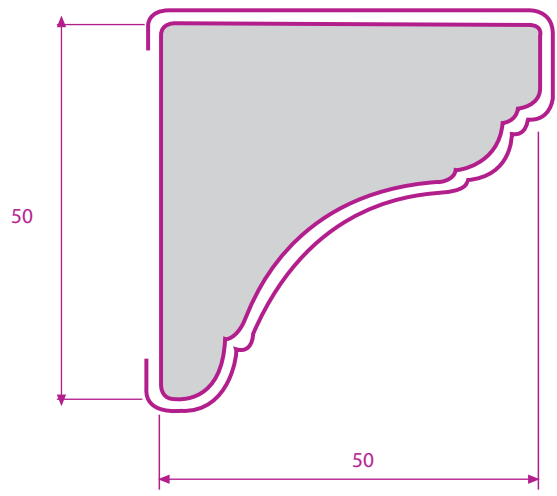

R-346

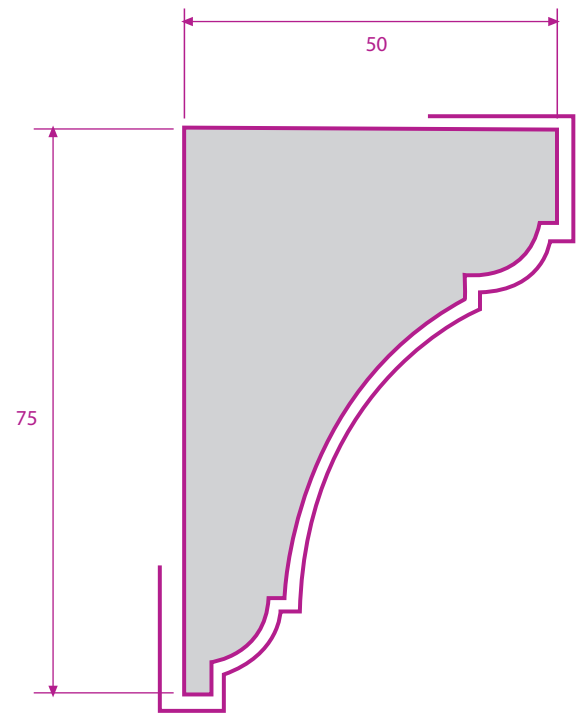

R-347

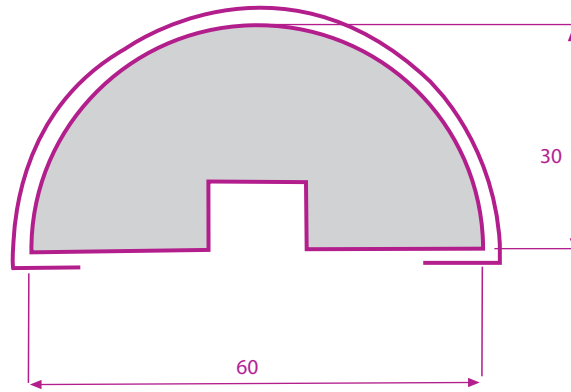

R-348

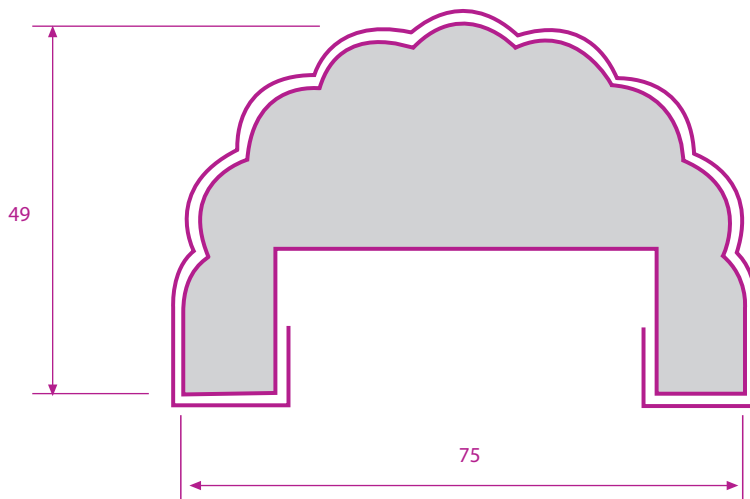

R-349

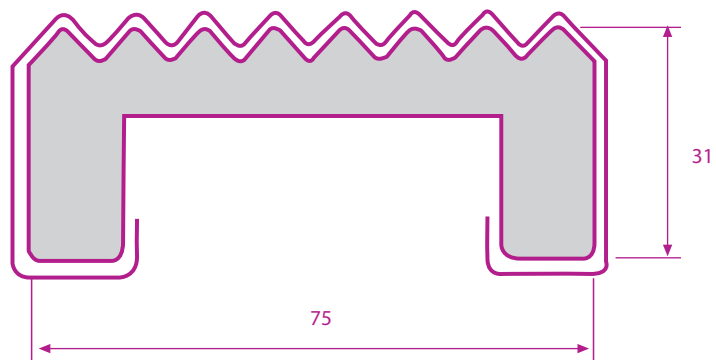

R-350

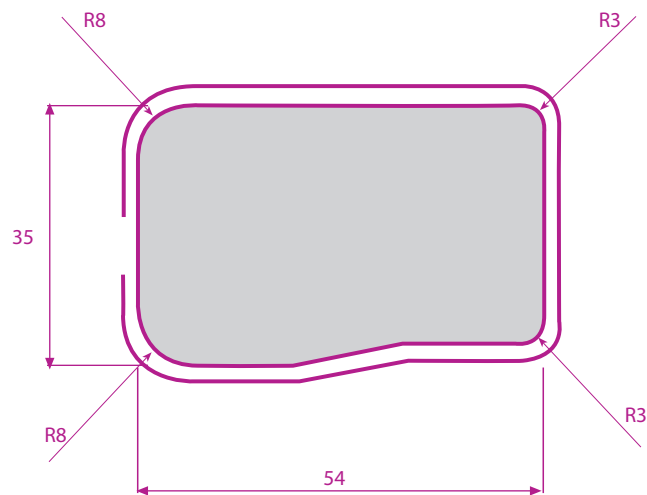

R-351

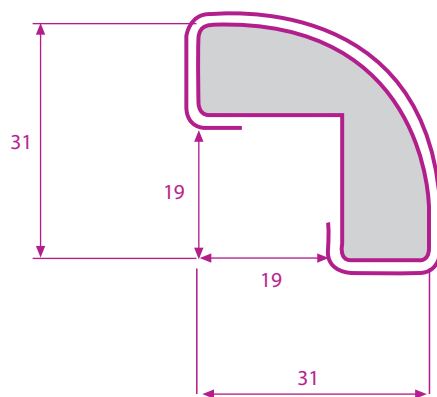

R-352

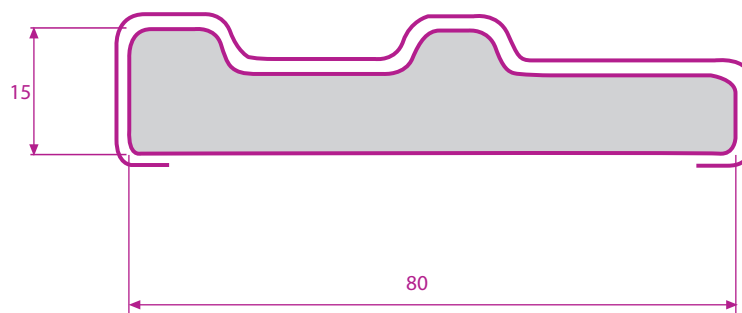

R-354

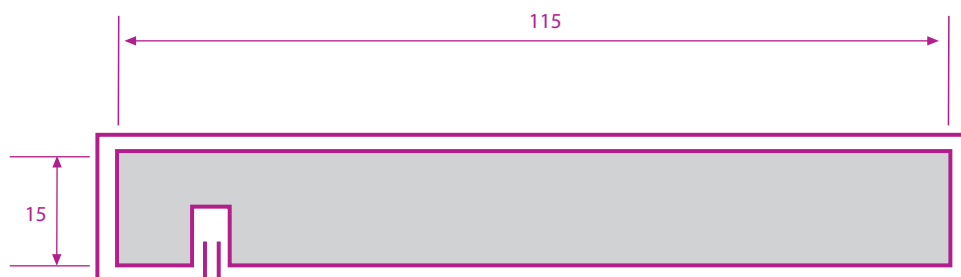

R-353

